

TPU TIME PROCESSOR UNIT REFERENCE MANUAL (INCLUDING THE TPU2)

Motorola reserves the right to make changes without further notice to any products herein. Motorola makes no warranty, representation or guarantee regarding the suitability of its products for any particular purpose, nor does Motorola assume any liability arising out of the application or use of any product or circuit, and specifically disclaims any and all liability, including without limitation consequential or incidental damages. "Typical" parameters can and do vary in different applications. All operating parameters, including "Typicals" must be validated for each customer application by customer's technical experts. Motorola does not convey any license under its patent rights nor the rights of others. Motorola products are not designed, intended, or authorized for use as components in systems intended for surgical implant into the body, or other applications intended to support or sustain life, or for any other application in which the failure of the Motorola product could create a situation where personal injury or death may occur. Should Buyer purchase or use Motorola products for any such unintended or unauthorized application, Buyer shall indemnify and hold Motorola and its officers, employees, subsidiaries, affiliates, and distributors harmless against all claims, costs, damages, and expenses, and reasonable attorney fees arising out of, directly or indirectly, any claim of personal injury or death associated with such unintended or unauthorized use, even if such claim alleges that Motorola was negligent regarding the design or manufacture of the part. Motorola and the Motorola logo are registered trademarks of Motorola, Inc. Motorola, Inc. is an Equal Opportunity/Affirmative Action Employer.

PREFACE

This manual describes the capabilities, operation, and functions of the time processor unit (TPU) and the enhanced TPU2, both of which are integral modules in Motorola's family of modular microcontrollers. Documentation for the Modular Microcontroller Family follows the modular construction of the devices in the product line. Each device has a comprehensive user's manual which provides sufficient information for normal operation of the device. The user's manual is supplemented by module reference manuals, including the TPU reference manual, that provide detailed information about module operation and applications. Refer to Motorola publication *Advanced Microcontroller Unit (AMCU) Literature* (BR1116/D) for a complete listing of documentation.

The following conventions are used throughout the manual.

The TPU and TPU2 are generically referred to as TPU except when specific differences require separate identification.

Logic level one is the voltage that corresponds to Boolean true (1) state.

Logic level zero is the voltage that corresponds to Boolean false (0) state.

To **set** a bit or bits means to establish logic level one on the bit or bits.

To **clear** a bit or bits means to establish logic level zero on the bit or bits.

A signal that is **asserted** is in its active logic state. An active low signal changes from logic level one to logic level zero when asserted, and an active high signal changes from logic level zero to logic level one.

A signal that is **negated** is in its inactive logic state. An active low signal changes from logic level zero to logic level one when negated, and an active high signal changes from logic level one to logic level zero.

LSB means least significant bit or bits. **MSB** means most significant bit or bits. References to low and high bytes are spelled.

A **specific bit or signal** within a range is referred to by mnemonic and number. For example, ADDR15 is bit 15 of the address bus. **A range of bits or signals** is referred to by mnemonic and the numbers that define the range. For example, DATA[7:0] form the low byte of the data bus.

This manual is intended for users of the pre-programmed time functions provided in microcoded ROM, as well as for those who wish to incorporate functions from the TPU function library.

This manual should be used in conjunction with programming notes for the individual TPU functions. Motorola Programming Note Literature Pack (TPULITPAK/D) provides available programming notes.

Programmers intending to modify existing time functions or develop their own micro-coded functions should read this manual and Motorola document number TPUMASM-REF/D1, *Time Processor Unit Programmer's Reference Manual*. In addition, they should consult Motorola Programming Note TPUPN00/D, *Using the TPU Function Library and TPU Emulation Mode*, as well as the programming notes for any pre-programmed time functions they intend to use or modify.

TABLE OF CONTENTS

Paragraph	Title	Page
SECTION 1 OVERVIEW		
1.1	Introduction	1-2
1.2	TPU Components	1-2
1.2.1	Time Bases	1-2
1.2.2	Timer Channels	1-2
1.2.3	Host Interface	1-2
1.2.4	Parameter RAM	1-3
1.2.5	Scheduler	1-3
1.2.6	Microengine	1-3
1.3	TPU Features	1-3
1.3.1	Emulation Support	1-3
1.3.2	Channel Orthogonality	1-4
1.3.3	Interchannel Communication	1-4
1.3.4	Coherency	1-4
1.4	TPU Memory Map	1-4
1.5	Signal Descriptions	1-6
SECTION 2 HOST INTERFACE		
2.1	System Configuration	2-1
2.1.1	TPUMCR Register	2-2
2.1.2	TPUMCR2 Register	2-6
2.2	Interrupts	2-8
2.2.1	Interrupt Levels	2-8
2.2.2	Interrupt Arbitration	2-9
2.2.3	Interrupt Vectors	2-9
2.2.4	Enabling Interrupts	2-9
2.2.5	Development Support and Test Registers	2-10
2.2.6	Channel Interrupt Registers	2-10
2.3	Channel Function Select Registers	2-11
2.4	Host Sequence Registers	2-12
2.5	Host Service Request Registers	2-12
2.6	Channel Priority Registers	2-13
2.7	Channel Parameter RAM	2-14
2.7.1	Parameter RAM Address Map	2-14
2.8	Configuration Summary	2-17
2.9	Configuration Examples	2-19
2.9.1	CPU32 Configuration Example	2-19
2.9.2	CPU16 Configuration Example	2-21

SECTION 3 SCHEDULER

TABLE OF CONTENTS (Continued)

Paragraph	Title	Page
3.1	Priority Scheme	3-1
3.1.1	Primary Scheme — Priority Among Channels on Different Levels	3-3
3.1.2	Secondary Scheme — Priority Among Channels on the Same Level	3-4
3.1.3	Correlation of Primary and Secondary Schemes	3-4
3.2	Time-Slot Latency	3-5
3.3	Disabling a Function	3-6

SECTION 4TPU EMULATION MODE

4.1	TPU Control Store Organization	4-2
4.2	Emulation Mode Memory Map	4-2
4.3	TPU Function Library	4-6
4.4	Emulation Mode Summary	4-7

APPENDIX ATPU FUNCTIONS

A.1	Mask Set A	A-1
A.2	Mask Set G	A-2
A.3	CHANNEL CONTROL Parameter	A-4
A.4	Period/Pulse-Width Accumulator (PPWA)	A-5
A.5	Output Compare (OC)	A-7
A.6	Stepper Motor (SM) Control	A-9
A.7	Position-Synchronized Pulse Generator (PSP)	A-11
A.8	Period Measurement with Additional Transition Detection (PMA)	A-13
A.9	Period Measurement with Missing Transition Detection (PMM)	A-15
A.10	Input Capture/Input Transition Counter (ITC)	A-17
A.11	Pulse-Width Modulation (PWM)	A-19
A.12	Discrete Input/Output (DIO)	A-21
A.13	Synchronized Pulse-Width Modulation (SPWM)	A-23
A.14	Quadrature Decode (QDEC)	A-26
A.15	Programmable Time Accumulator (PTA)	A-28
A.16	Queued Output Match TPU Function (QOM)	A-30
A.17	Table Stepper Motor (TSM)	A-32
A.18	Frequency Measurement (FQM)	A-35
A.19	Universal Asynchronous Receiver/Transmitter (UART)	A-37
A.20	New Input Capture/Transition Counter (NITC)	A-40
A.21	Multiphase Motor Commutation (COMM)	A-42
A.22	Multichannel Pulse-Width Modulation (MCPWM)	A-44
A.23	Hall Effect Decode (HALLD)	A-51
A.24	Fast Quadrature Decode TPU Function (FQD)	A-53

APPENDIX B MEMORY MAP AND REGISTERS

TABLE OF CONTENTS (Continued)

Paragraph	Title	Page
B.1	Memory Map	B-1
B.2	Registers	B-2
B.2.1	TPU Module Configuration Register	B-2
B.2.2	Test Configuration Register	B-4
B.2.3	Development Support Control Register	B-4
B.2.4	Development Support Status Register	B-5
B.2.5	TPU Interrupt Configuration Register	B-5
B.2.6	Channel Interrupt Enable Register	B-6
B.2.7	Channel Function Select Registers	B-6
B.2.8	Host Sequence Registers	B-7
B.2.9	Host Service Request Registers	B-7
B.2.10	Channel Priority Registers	B-7
B.2.11	Channel Interrupt Status Register	B-8
B.2.12	Link Register	B-8
B.2.13	Service Grant Latch Register	B-9
B.2.14	Decoded Channel Number Register	B-9
B.2.15	TPUMCR2 Module Configuration Register 2	B-9
B.2.16	TPU Parameter RAM	B-10

APPENDIX C ESTIMATING WORST-CASE LATENCY

C.1	Introduction to Worst-Case Latency	C-1
C.2	Using Worst-Case Latency Estimates to Evaluate Performance	C-3
C.3	Priority Scheme Details Used in WCL Analysis	C-3
C.3.1	Priority Passing	C-4
C.3.2	Time-Slot Transition	C-5
C.3.3	Channel Number Priority	C-5
C.3.4	RAM Collision Rate	C-5
C.4	First-Pass Worst-Case Latency Analysis	C-6
C.4.1	Worst-Case Assumptions and Formula	C-6
C.4.1.1	Finding the Worst-Case Service Time for Each Active Channel ...	C-7
C.4.1.2	Mapping the Channels for Each Time Slot	C-8
C.4.1.3	Adding Time for Time-Slot Transitions and NOPs	C-8
C.4.2	First-Pass Analysis Worst-Case Latency Examples	C-8
C.4.2.1	Finding the WCL for PWM on Channel 0	C-8
C.4.2.2	Finding the WCL for PPWA on Channel 1	C-9
C.4.2.3	Finding the WCL for DIO on Channel 2	C-10
C.5	Second-Pass Worst-Case Latency Analysis	C-11
C.5.1	Second-Pass Analysis Guidelines	C-11
C.5.2	Second-Pass Analysis Example	C-12
C.5.2.1	First-Try System Configuration	C-13
C.5.2.2	Second-Try System Configuration	C-14

TABLE OF CONTENTS
(Continued)

Paragraph

Title

Page

APPENDIX DCHANNEL HARDWARE DIAGRAM

LIST OF ILLUSTRATIONS

Figure	Title	Page
1-1	TPU Block Diagram	1-1
1-2	TPU Pins	1-6
2-1	TCR1 Prescaler Control	2-3
2-2	TCR2 Prescaler Control 2	2-3
2-3	Parameter RAM Arbitration Timing, Word Access by Host	2-16
2-4	Parameter RAM Arbitration Timing, Word or Long-Word Access by TPU ...	2-17
2-5	Channel Control and Parameter RAM Configuration	2-18
3-1	Priority Levels	3-2
3-2	Priority Passing	3-3
3-3	Time-Slot Variation	3-5
4-1	On-Chip RAM Configuration	4-1
4-2	TPU Control Store and 2-Kbyte Emulation RAM Map	4-3
4-3	TPU2 Micro-Store Size Configurations	4-4
4-4	Extending Microcode Segment by Means of Unused Entry Points	4-5
4-5	1-Kbyte Emulation RAM Memory Map	4-6
A-1	PPWA Parameters	A-6
A-2	OC Parameters	A-8
A-3	SM Parameters, Part 1 of 2	A-10
A-4	SM Parameters, Part 2 of 2	A-11
A-5	PSP Parameters	A-12
A-6	PMA Parameters	A-14
A-7	PMM Parameters	A-16
A-8	ITC Parameters	A-18
A-9	PWM Parameters	A-20
A-10	DIO Parameters	A-22
A-11	SPWM Parameters, Part 1 of 2	A-24
A-12	SPWM Parameters, Part 2 of 2	A-25
A-13	QDEC Parameters	A-27
A-14	PTA Parameters	A-29
A-15	QOM Parameters	A-31
A-16	TSM Parameters — Master Mode	A-33
A-17	TSM Parameters — Slave Mode	A-34
A-18	FQM Parameters	A-36
A-19	UART Transmitter Parameters	A-38
A-20	UART Receiver Parameters	A-39
A-21	NITC Parameters	A-41
A-22	COMM Parameters, Part 1 of 2	A-43
A-23	COMM Parameters, Part 2 of 2	A-44
A-24	MCPWM Parameters — Master Mode	A-45
A-25	MCPWM Parameters — Slave Edge-Aligned Mode	A-46
A-26	MCPWM Parameters — Slave Ch A Non-Inverted Center-Aligned Mode ...	A-47

LIST OF ILLUSTRATIONS (Continued)

Figure	Title	Page
A-27	MCPWM Parameters — Slave Ch B Non-Inverted Center-Aligned Mode ...	A-48
A-28	MCPWM Parameters — Slave Ch A Inverted Center-Aligned Mode	A-49
A-29	MCPWM Parameters — Slave Ch B Inverted Center-Aligned Mode	A-50
A-30	HALLD Parameters	A-52
A-31	FQD Parameters — Primary Channel	A-54
A-32	FQD Parameters — Secondary Channel	A-55
C-1	Worst-Case Latency for PWM	C-1
C-2	TPU Function States	C-2
C-3	Time-Slot Sequence	C-4
C-4	Multiple Time-Slot Sequences	C-4
C-5	First-Pass Worst-Case Latency	C-6
C-6	Next Servicing for Channel 0	C-9
C-7	Next Servicing for Channel 1	C-10
C-8	Next Servicing for Channel 2	C-11
C-9	Worst-Case Latency for Channel 0 (First Try)	C-14
C-10	Worst-Case Latency for Channel 0 (Second Try)	C-15
C-11	Worst-Case Latency for Channel 2	C-15
D-1	Channel Hardware Block Diagram	D-2

LIST OF TABLES

Table	Title	Page
1-1	TPU Address Map	1-5
2-1	TPUMCR/TPUMCR2 Bit Configuration Fields.....	2-1
2-2	TCR1 Prescaler Control.....	2-2
2-3	TCR2 Prescaler Output	2-4
2-4	TPU/TPU2 Reset with Flash EEPROM	2-4
2-5	TCR2 Counter Clock Source	2-5
2-6	Divide by 2 Control	2-6
2-7	Entry Table Bank Location.....	2-7
2-8	System Clock Frequency/Minimum Detected Pulse.....	2-8
2-9	Channel Priorities	2-13
2-10	Parameter RAM Address Map.....	2-14
3-1	Priority Passing.....	3-3
A-1	Mask Set A Time Function Encodings	A-2
A-2	Mask Set G Time Function Encodings	A-3
A-3	CHANNEL CONTROL Options	A-4
A-4	QOM Bit Encoding.....	A-30
B-1	TPU Address Map	B-1
B-2	TPU/TPU2 Reset with Flash EEPROM.....	B-3
B-3	TCR2 Counter Clock Source.....	B-3
B-4	FRZ[1:0] Bit Field	B-4
B-5	Channel Priorities.....	B-8
B-6	Entry Table Bank Location	B-9
B-7	System Clock Frequency/Minimum Guaranteed Detected Pulse	B-10
B-8	Parameter RAM Address Map	B-10
C-1	Longest States and RAM Accesses for Mask Set A Functions.....	C-7
C-2	System Configuration Example.....	C-8
C-3	Worst-Case Latency for Channel 0.....	C-9
C-4	Worst Case Latency for Channel 1	C-10
C-5	Worst Case Latency for Channel 2	C-11
C-6	First-Try System Configuration	C-13
C-7	Second-Try System Configuration	C-14
C-8	Second-Try System with Channel 0 and 1 Reconfigured	C-15

LIST OF TABLES
(Continued)
Title

Table

Page

SECTION 1 OVERVIEW

The following section provides general information on the time processor unit (TPU) and the enhanced TPU2.

NOTE

The TPU and TPU2 are generically referred to as TPU except when specific differences require separate identification.

The TPU is an intelligent, semi-autonomous co-processor designed for timing control. Operating simultaneously with the CPU, the TPU processes microinstructions, schedules and processes real-time hardware events, performs input and output, and accesses shared data without CPU intervention. Consequently, for each timer event, the CPU setup and service time are minimized or eliminated. **Figure 1-1** is a simplified block diagram of the TPU.

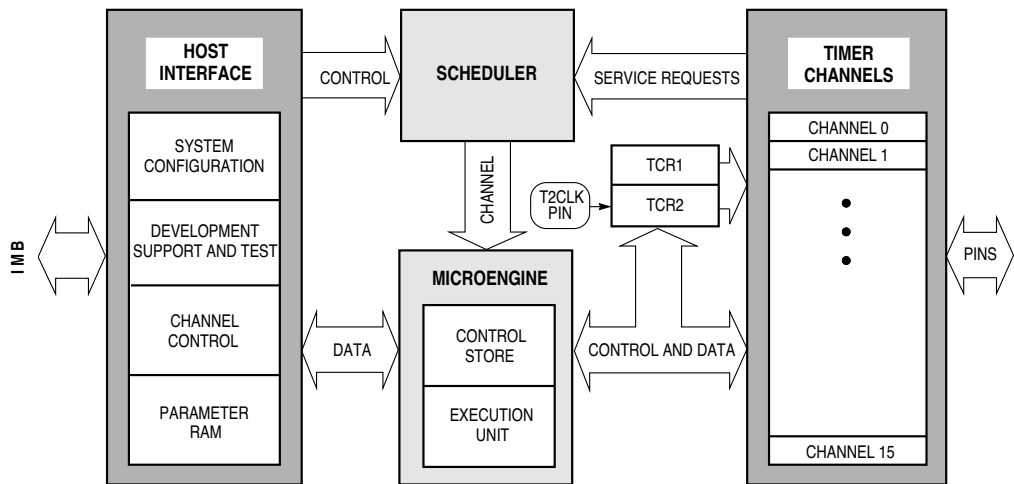

TPU BLOCK

Figure 1-1 TPU Block Diagram

1.1 Introduction

The TPU module includes a set of pre-programmed functions microcoded in ROM. Different ROM mask sets are provided with different microcontrollers (MCUs). Refer to the appropriate MCU user's manual for a list of the time functions provided. Pre-programmed time functions for the two mask sets currently in production are described briefly in **APPENDIX A TPU FUNCTIONS**. In addition, individual programming notes for each function describe the functions in greater detail and provide application examples. Refer to Motorola Programming Note TPUPN00/D, *Using the TPU Function Library and TPU Emulation Mode*, for a list of available programming notes for individual functions.

1.2 TPU Components

The TPU module consists of two 16-bit time bases, sixteen independent timer channels, a task scheduler, a microengine, and a host interface. In addition, a dual-port parameter RAM is used for TPU data storage and for passing parameters between the module and the host CPU.

1.2.1 Time Bases

Two 16-bit counters provide reference time bases for all output compare and input capture events. Prescalers for both time bases are controlled by the host CPU through bit fields in the TPU module configuration register (TPUMCR). The TPU2 uses an additional control register (TPUMCR2). The TCR1 clock is always derived from the system clock. The TCR2 clock can be derived from the system clock or from an external input via the T2CLK clock pin. The duration between active edges on the T2CLK clock pin must be at least nine system clocks.

1.2.2 Timer Channels

The TPU has 16 independent channels, each connected to an MCU pin. The channels have identical hardware with the exception of channel 15 on the TPU2, which has additional output disable logic. Each channel consists of an event register and pin control logic. The event register contains a 16-bit capture register, a 16-bit compare/match register, and a 16-bit greater-than-or-equal-to comparator. The direction of each pin, either output or input, is determined by the TPU microengine. Each channel can either use the same time base for match and capture, or can use one time base for match and the other for capture.

1.2.3 Host Interface

The host interface allows the host CPU to control the operation of the TPU. The host CPU must initialize the TPU by writing to the appropriate host interface registers to assign a function, interrupt level, and priority to each channel. In addition, the CPU writes to the host service request and host sequence registers to further define function operation for each initialized channel. Refer to **SECTION 2 HOST INTERFACE** for a description of the host interface, including register bit/field definitions.

1.2.4 Parameter RAM

TPU parameter RAM occupies 200 bytes at the top of the TPU module address map. Channel parameters are organized as 100 16-bit words. Channels 0 to 13 have six parameters; channels 14 and 15 each have eight parameters.

TPU2 parameter RAM occupies 256 bytes at the top of the TPU2 module address map. Channel parameters are organized as 128 16-bit words. Channels 0 through 15 each have eight parameters.

Refer to paragraphs **1.4 TPU Memory Map** and **2.7.1 Parameter RAM Address Map** for information on how parameter words are organized in memory.

The parameter RAM is used as a dual-ported communication RAM for the TPU and the host CPU. The parameters required by each pre-programmed time function are shown in **APPENDIX A TPU FUNCTIONS** and described in detail in individual programming notes.

1.2.5 Scheduler

Out of reset, all channels are disabled. The host CPU makes a channel active by assigning it one of three priorities: high, middle, or low. The scheduler determines the order in which channels are serviced based on channel number and assigned priority. Refer to **SECTION 3 SCHEDULER** for additional details.

1.2.6 Microengine

The microengine is composed of a control store and an execution unit. Control-store ROM holds the microcode for each factory-masked function. Alternatively, in emulation mode, microcode is executed from the TPURAM module instead of the control store. Emulation mode allows the development of custom TPU functions. Refer to **SECTION 4 TPU EMULATION MODE** for more information.

1.3 TPU Features

Important TPU features are summarized in the following paragraphs.

1.3.1 Emulation Support

To support changing TPU application requirements, Motorola has established a TPU function library. The function library is a collection of TPU functions written for easy assembly in combination with each other or with custom functions. In emulation mode, the TPU uses an on-chip RAM module (TPURAM) as control store instead of the TPU control store ROM. There is no performance loss in emulation mode; functions execute as quickly as they would in TPU control ROM. Notice that in emulation mode, the CPU cannot access the TPURAM. Refer to **SECTION 4 TPU EMULATION MODE** for information on TPU emulation mode. See Motorola Programming Note TPUPN00/D, *Using the TPU Function Library and TPU Emulation Mode*, for details on the TPU function library.

1.3.2 Channel Orthogonality

All TPU channels contain identical hardware and are functionally equivalent in operation. This allows any channel to be configured to perform any time function. The user controls the combination of functions.

1.3.3 Interchannel Communication

The autonomy of the TPU is enhanced by the ability of a channel to affect the operation of one or more other channels without CPU intervention. Interchannel communication allows one channel to control multiple channels, or allows multiple functions to interact.

1.3.4 Coherency

For data to be coherent, all available portions of it must be identical in age or logically related. As an example, consider a 32-bit counter value that is read and written as two 16-bit words. The 32-bit value is read-coherent only if both 16-bit portions are updated at the same time, and write-coherent only if both portions take effect at the same time. Parameter RAM hardware supports coherent access of two adjacent 16-bit parameters. The host CPU must use a long-word operation to guarantee coherency.

1.4 TPU Memory Map

TPU registers and parameter RAM are mapped into a 512-byte address space. Unused registers within the 512-byte address space return zeros when read. All registers except the channel interrupt status register (CISR), which permits byte accesses, must be read or written through word or long-word accesses.

The TPU address map is shown in **Table 1-1**. The column labeled “Access” indicates the privilege level required to access the register. A designation of “S” indicates that supervisor access is required; a designation of “S/U” indicates that the register can be programmed (by setting or clearing a bit in the TPUMCR) for supervisor access only or for both supervisor and user access.

Table 1-1 provides TPU register addresses relative to the TPU base address. In this table, the high-order part of each address is listed as ###. Refer to the user’s manual for the specific MCU for the exact location of the registers. The most significant bit of the address is determined by the module mapping (MM) bit in the SIM or SCIM configuration register. The shaded area applies to the TPU2 only.

Table 1-1 TPU Address Map

Access	Address	15	8 7	0
S ¹	####E00	TPU MODULE CONFIGURATION REGISTER (TPUMCR)		
S	####E02	TPU TEST CONFIGURATION REGISTER (TCR)		
S	####E04	DEVELOPMENT SUPPORT CONTROL REGISTER (DSCR)		
S	####E06	DEVELOPMENT SUPPORT STATUS REGISTER (DSSR)		
S	####E08	TPU INTERRUPT CONFIGURATION REGISTER (TICR)		
S	####E0A	CHANNEL INTERRUPT ENABLE REGISTER (CIER)		
S	####E0C	CHANNEL FUNCTION SELECT REGISTER 0 (CFSR0)		
S	####E0E	CHANNEL FUNCTION SELECT REGISTER 1 (CFSR1)		
S	####E10	CHANNEL FUNCTION SELECT REGISTER 2 (CFSR2)		
S	####E12	CHANNEL FUNCTION SELECT REGISTER 3 (CFSR3)		
S/U ²	####E14	HOST SEQUENCE REGISTER 0 (HSQR0)		
S/U	####E16	HOST SEQUENCE REGISTER 1 (HSQR1)		
S/U	####E18	HOST SERVICE REQUEST REGISTER 0 (HSRR0)		
S/U	####E1A	HOST SERVICE REQUEST REGISTER 1 (HSRR1)		
S	####E1C	CHANNEL PRIORITY REGISTER 0 (CPR0)		
S	####E1E	CHANNEL PRIORITY REGISTER 1 (CPR1)		
S	####E20	CHANNEL INTERRUPT STATUS REGISTER (CISR)		
S	####E22	LINK REGISTER (LR)		
S	####E24	SERVICE GRANT LATCH REGISTER (SGLR)		
S	####E26	DECODED CHANNEL NUMBER REGISTER (DCNR)		
S	####E28	TPU2 MODULE CONFIGURATION REGISTER 2 (TPUMCR2) — TPU2 ONLY		
S/U	###F00 – ###F0E	CHANNEL 0 PARAMETER REGISTERS		
S/U	###F10 – ###F1E	CHANNEL 1 PARAMETER REGISTERS		
S/U	###F20 – ###F2E	CHANNEL 2 PARAMETER REGISTERS		
S/U	###F30 – ###F3E	CHANNEL 3 PARAMETER REGISTERS		
S/U	###F40 – ###F4E	CHANNEL 4 PARAMETER REGISTERS		
S/U	###F50 – ###F5E	CHANNEL 5 PARAMETER REGISTERS		
S/U	###F60 – ###F6E	CHANNEL 6 PARAMETER REGISTERS		
S/U	###F70 – ###F7E	CHANNEL 7 PARAMETER REGISTERS		
S/U	###F80 – ###F8E	CHANNEL 8 PARAMETER REGISTERS		
S/U	###F90 – ###F9E	CHANNEL 9 PARAMETER REGISTERS		
S/U	###FA0 – ###FAE	CHANNEL 10 PARAMETER REGISTERS		
S/U	###FB0 – ###FBE	CHANNEL 11 PARAMETER REGISTERS		
S/U	###FC0 – ###FCE	CHANNEL 12 PARAMETER REGISTERS		
S/U	###FD0 – ###FDE	CHANNEL 13 PARAMETER REGISTERS		
S/U	###FE0 – ###FEE	CHANNEL 14 PARAMETER REGISTERS		
S/U	###FF0 – ###FFE	CHANNEL 15 PARAMETER REGISTERS		

NOTES:

1. S = Supervisor accessible only.
2. S/U = Supervisor accessible only (if SUPV = 1) or unrestricted (if SUPV = 0). Unrestricted registers allow both user and supervisor access.

1.5 Signal Descriptions

There are 17 external pins associated with the TPU: 16 channel pins and the T2CLK pin. These signals are illustrated in **Figure 1-2**.

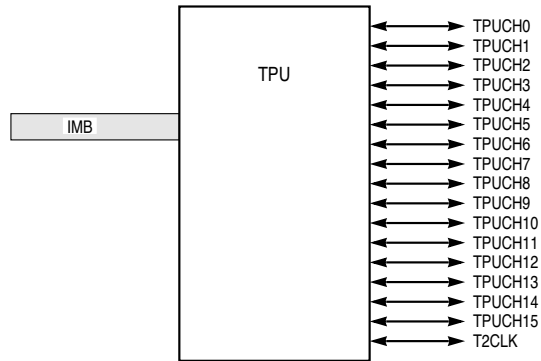

1015A

Figure 1-2 TPU Pins

The direction of each channel pin, either output or input, is determined by the function. The T2CLK pin is used to clock or gate the TCR2 counter. Refer to **2.1 System Configuration** for proper use of this pin.

SECTION 2 HOST INTERFACE

The following section describes the host interface to the TPU. The registers described in this section configure the TPU as a whole, the 16 individual channels, and the parameter registers within the RAM used to exchange parameters between the TPU and host CPU.

NOTE

All registers are 16 bits in length and are only accessible through word transfers with one exception – the channel interrupt status register (CISR) can also be accessed on a byte basis. This allows the CPU to perform bit manipulation instructions on the CISR only. A byte write of any TPU register other than the CISR sets the other byte of the word to \$FF.

2.1 System Configuration

The TPU module configuration register (TPUMCR) contains the bit fields that define TPU and TPU2 module attributes. The TPUMCR resides in supervisor data space.

The TPU2 module contains an additional system configuration register, the TPU module configuration register 2 (TPUMCR2). The TPUMCR2 resides in supervisor data space.

Table 2-1 provides an overview of the different bits and bit fields found in the TPU and TPU2 module configuration registers.

Table 2-1 TPUMCR/TPUMCR2 Bit Configuration Fields

Register Name	Module	Bit/Field Name	Mnemonic	Bit Position
TPUMCR	TPU, TPU2	Stop control	STOP	15
		TCR1 Prescaler control field	TCR1P[1:0]	14-13
		TCR2 Prescaler control field	TCR2P[1:0]	12-11
		Emulation control	EMU	10
		Timer count register 2 clock control field	T2CG	9
		Stop flag	STF	8
		Supervisor/unrestricted	SUPV	7
		Prescaler clock	PSCK	6
		Interrupt arbitration field	IARB[3:0]	3-1
TPUMCR2	TPU2	TPU2 enable	TPU2	5
		TCR2 counter clock edge	T2CSL	4
		Divide by two control	DIV2	8
		Soft reset	SOFT_RST	7
		Entry table bank	ETBANK[1:0]	6-5
		Filter prescaler clock	FPSCK[2:0]	4-2
		T2CLK pin filter control	T2CF	1
		Disable TPU2 pins	DTPU	0

2.1.1 TPUMCR Register

The TPUMCR controls configuration parameters in the TPU and the TPU2. Register diagrams and bit/field descriptions follow.

TPUMCR — TPU Module Configuration Register

####E00

15	14	13	12	11	10	9	8	7	6	5	4	3	2	1	0
STOP	TCR1P[1:0]	TCR2P[1:0]	EMU ¹	T2CG	STF	SUPV	PSCK	TPU2 ²	T2CSL ³	IARB[3:0]					
RESET:															
0	0	0	0	0	0	0	0	1	0	1	0	0	0	0	0

NOTES:

1. On TPU2, this bit is set or cleared according to the shadow bit for bit four of the flash EEPROM module configuration (FEEMCR) register.
2. After reset, the TPU2 enable (TPU2) bit is zero if TPU module is present. In this case, the bit cannot be modified. If the TPU2 module is present, the TPU2 enable bit is one after reset.
3. After reset, TCR2 counter clock edge (T2CSL) bit is zero if the TPU module is present. In this case, the bit cannot be modified. If the TPU2 module is present, this bit is zero after reset and can be modified.

STOP — Stop Bit

When the STOP bit in the TPUMCR is set, the TPU shuts down its internal clocks, shutting down the internal microengine. TCR1 and TCR2 cease to increment and retain the last value before the stop condition was entered. The TPU asserts the stop flag (STF) in the TPUMCR to indicate that it has stopped.

When the STOP bit is set, the CPU can access all registers it can normally access except the priority registers. Accessing the priority registers causes a bus-error exception from the internal bus monitor. Refer to the appropriate MCU user's manual or to the *SIM Reference Manual (SIMRM/AD)* or *SCIM Reference Manual (SCIMRM/AD)* for information on the internal bus monitor.

- 0 = TPU operating normally
- 1 = Internal clocks shut down

TCR1P — Timer Count Register 1 Prescaler Control

Timer count register 1 (TCR1) is clocked from the output of a prescaler. In the TPU, two fields (PSCK, TCR1P) in the TPUMCR control TCR1. In the TPU2, an additional field is required — DIV2, which is located in the TPUMCR2.

The input to the prescaler is the internal TPU system clock divided by either four or 32, depending on the value of the PSCK bit. The prescaler divides this input by one, two, four, or eight, depending on the value of TCR1P. Refer to **Figure 2-1** and **Table 2-2**.

In the TPU2, if the DIV2 bit is one, the TCR1 counter increments at a rate of the internal clock divided by two. If DIV2 is zero, the TCR1 increment rate is defined by the values in **Table 2-2**.

Table 2-2 TCR1 Prescaler Control

TCR1P	Divide By	PSCK = 0		PSCK = 1	
		Number of Clocks	Rate at 16 MHz	Number of Clocks	Rate at 16 MHz
00	1	32	2 μs	4	250 ns
01	2	64	4 μs	8	500 ns
10	4	128	8 μs	16	1 μs
11	8	256	16 μs	32	2 μs

Figure 2-1 shows a diagram of the TCR1 prescaler control block.

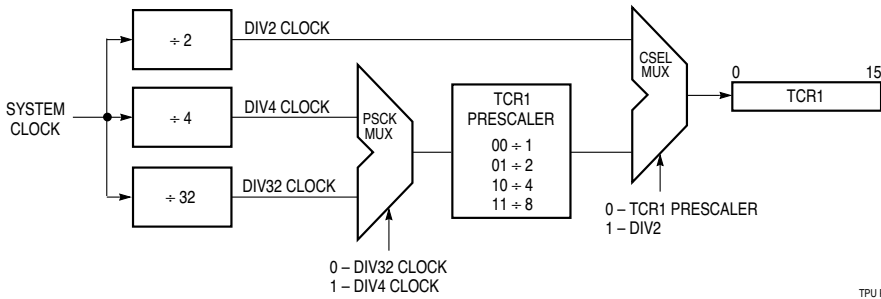

TPU PRE BLOCK 1

Figure 2-1 TCR1 Prescaler Control

TCR2P — Timer Count Register 2 Prescaler Control

Timer count register two (TCR2), like TCR1, is clocked from the output of a prescaler. The T2CG (TCR2 clock/gate control) bit in TPUMCR determines whether the external TCR2 pin functions as an external clock source for TCR2 or as the gate in the use of TCR2 as a gated pulse accumulator.

In the TPU2, the T2CG bit and the T2CSL bit determine TCR2 pin functions.

The function of the T2CG bit is shown in **Figure 2-2**.

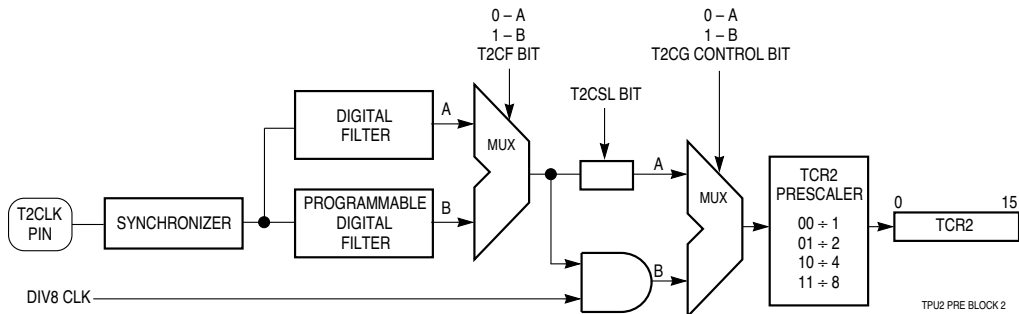

TPU2 PRE BLOCK 2

Figure 2-2 TCR2 Prescaler Control 2

When the T2CG bit is set, the external T2CLK pin functions as a gate of the DIV8 clock (the TPU system clock divided by eight). In this case, when the external TCR2 pin is low, the DIV8 clock is blocked, preventing it from incrementing TCR2. When the external TCR2 pin is high, TCR2 is incremented at the frequency of the DIV8 clock. When the T2CG bit is cleared, an external clock from the TCR2 pin increments TCR2. The duration between active edges on the T2CLK clock pin must be at least nine system clocks.

The TCR2 pin and each channel configured as an input have an associated synchronizer followed by a digital filter connected to the pin that samples pin transitions. These

filter out high and low pulse widths less than the period of two system clocks, preventing these transitions from being input to the transition detect logic. The synchronizer and digital filter are guaranteed to pass pulses that are greater than the period of four system clocks.

The TCR2 field in TPUMCR specifies the value of the prescaler: one, two, four, or eight. Channels using TCR2 have the capability to resolve down to the TPU system clock divided by eight. **Table 2-3** is a summary of prescaler output.

Table 2-3 TCR2 Prescaler Output

TCR2 Prescaler	Divide By	Internal Clock Divided By	External Clock Divided By
00	1	8	1
01	2	16	2
10	4	32	4
11	8	64	8

EMU — Emulation Control

Emulation mode is entered by setting the EMU bit in the TPUMCR. In emulation mode, an auxiliary bus connection is made between TPURAM and the TPU module, and access to TPURAM via the intermodule bus is disabled. A 9-bit address bus, a 32-bit data bus, and control lines transfer information between the modules. To ensure exact emulation, TPURAM module access timing remains consistent with access timing of the TPU ROM control store.

The TPU function library is a collection of TPU functions written for easy assembly in combination with each other or with custom functions. TPU emulation capability allows the user to use the TPU library functions and develop new time functions. Refer to **SECTION 4 TPU EMULATION MODE** for information about emulation mode, and to Motorola Programming Note TPUPN00/D, *Using the TPU Function Library and TPU Emulation Mode*, for details on the TPU function library.

0 = TPU and TPURAM in normal mode (operating as separate modules)

1 = TPU and TPURAM in emulation mode

After reset, this bit can be written only once.

When the TPU or TPU2 module is used with a flash EEPROM, the EMU bit is either set or cleared upon a reset according to the conditions shown in **Table 2-4**.

Table 2-4 TPU/TPU2 Reset with Flash EEPROM

Module	Reset Condition
TPU	EMU bit is cleared out of reset.
TPU2	If the shadow bit for bit four of the flash EEPROM module configuration register (FEEMCR) for the 4-Kbyte flash block is set, the EMU bit is cleared out of reset.
	If the shadow bit for bit four of the FEEMCR for the 4-Kbyte flash block is clear, the EMU bit is set out of reset.

T2CG — TCR2 Clock/Gate Control

In the TPU, the following states apply:

0 = TCR2 pin used as clock source for TCR2

1 = TCR2 pin used as gate of DIV8 clock for TCR2

In the TPU2, T2CG control bit and the T2CSL control bit determine the clock source for TCR2.

STF — Stop Flag

0 = TPU operating

1 = TPU stopped (STOP bit has been asserted)

SUPV — Supervisor Data Space

In systems that support privilege levels, the CPU can operate at either of two levels: user or supervisor. Certain TPU registers can be accessed only when the CPU is operating at the supervisor level. Other registers can be assigned supervisor-only access by setting the SUPV bit in the TPUMCR. When SUPV is cleared, the programmable registers are accessible from either the supervisor or user privilege level. In systems that do not support privilege levels, the CPU always operates at the supervisor level.

When SUPV is cleared, if a supervisor-only register is accessed from the user privilege level, the module responds as though an access had been made to an unimplemented register location. When SUPV is set, accesses to all TPU registers from the user privilege level are transferred externally.

The S bit in the CPU status register determines the privilege level at which the CPU is operating (0 = user level, 1 = supervisor level). Refer to the appropriate CPU reference manual for more information on privilege levels.

0 = Assignable registers are accessible from user or supervisor privilege level

1 = Assignable registers are accessible from supervisor privilege level only

PSCK — Prescaler Clock

0 = System clock/32 is input to TCR1 prescaler

1 = System clock/4 is input to TCR1 prescaler

TPU2 — TPU2 Enable

In the TPU2, the TPU2 enable bit provides compatibility with the TPU. If running TPU code on the TPU2, the microcode size should not be greater than two Kbytes and the TPU2 enable bit should be cleared to zero. The TPU2 enable bit is write-once after reset. The reset value is one, meaning that the TPU2 will operate in TPU2 mode.

0 = TPU mode; zero is the TPU reset value.

1 = TPU2 mode; one is the TPU2 reset value.

NOTE

The programmer should not change this value unless necessary when developing custom TPU microcode.

T2CSL — TCR2 Counter Clock Edge

In the TPU2, this bit and the T2CG control bit determine the clock source for TCR2. Refer to **Table 2-5**.

Table 2-5 TCR2 Counter Clock Source

T2CSL	T2CG	TCR2 Clock
0	0	Rise transition T2CLK
0	1	Gated system clock
1	0	Fall transition T2CLK
1	1	Rise and fall transition T2CLK

IARB — Interrupt Arbitration Number

This field contains the TPU arbitration number that is used to arbitrate for the intermodule bus when two or more modules or peripherals have an interrupt on the same priority level. The highest arbitration priority is \$F, and the lowest is one. An IARB value of zero causes the TPU not to arbitrate for the intermodule bus during an interrupt-acknowledge cycle. Refer to **2.2.2 Interrupt Arbitration** for more information.

2.1.2 TPUMCR2 Register

The TPUMCR2 controls the configuration parameters discussed in the preceding paragraphs. A register diagram and brief bit/field descriptions follow.

TPUMCR2 — TPU Module Configuration Register 2 (TPU2 Only)

###E28

15	14	13	12	11	10	9	8	7	6	5	4	3	2	1	0
0	0	0	0	0	0	0	DIV2	SOFT RST	ETBANK[1:0]	FPSCK[2:0]		T2CF	DTPU		

RESET:

0 0 0 0 0 0 0 0 0 0 0 0 0 0 0 0

DIV2 — Divide by 2 Control

When asserted, the DIV2 bit, along with the TCR1P bit and the PSCK bit in the TPUMCR, determines the rate of the TCR1 counter in the TPU2. If set, the TCR1 counter increments at a rate of two system clocks. If negated, TCR1 increments at the rate determined by control bits in the TCR1P and PSCK fields. Refer to **Table 2-6**.

Table 2-6 Divide by 2 Control

DIV2	PSCK	TCR1P	Clocks	Rate at 16.7 MHz	Rate at 20 MHz
1	X	XX	2	125 ns	100 ns

0 = TCR1 increments at rate determined by control bits in the TCR1P and PSCK fields of the TPUMCR register.

1 = Causes TCR1 counter to increment at a rate of the system clock frequency divided by two.

SOFT RST — Soft Reset

The TPU2 performs an internal reset when both the SOFT RST bit in the TPUMCR2 and the STOP bit in TPUMCR are set. CPU must write zero to the SOFT RST bit to bring the TPU2 out of reset. The SOFT RST bit must be asserted for at least nine clocks.

NOTE

Do not attempt to access any other TPU2 registers when this bit is asserted. When this bit is asserted, it is the only accessible bit in the register.

0 = Normal operation

1 = Puts TPU2 in reset until bit is cleared, but only if the STOP bit in the TPUMCR is also set.

ETBANK[1:0] — Entry Table Bank Select

In the TPU2, the entry table bank (ETBANK[1:0]) field determines the bank where the microcoded entry table is situated. After reset, this field is %00. This control bit field is write once after reset. ETBANK[1:0] is used when the microcode contains entry tables not located in the default bank 0. To execute the ROM functions on this MCU, ETBANK[1:0] must be 00. Refer to **Table 2-7**.

NOTE

This field should not be modified by the programmer unless necessary because of custom microcode.

Table 2-7 Entry Table Bank Location

ETBANK	BANK
00	0
01	1
10	2
11	3

FPSCCK[2:0] — Filter Prescaler Clock Control

In the TPU2, the filter prescaler clock control bit field determines the ratio between system clock frequency and minimum detectable pulses. The reset value of these bits is zero, defining the filter clock as four system clocks. Refer to **Table 2-8**.

Table 2-8 System Clock Frequency/Minimum Detected Pulse

Filter Control	Divide By	16.7 MHz	20 MHz
000	4	240 ns	200 ns
001	8	480 ns	400 ns
010	16	960 ns	800 ns
011	32	1.92 μ s	1.6 μ s
100	64	3.84 μ s	3.2 μ s
101	128	7.68 μ s	6.4 μ s
110	256	15.36 μ s	12.8 μ s
111	512	30.72 μ s	25.6 μ s

T2CF — T2CLK Pin Filter Control

When asserted, the T2CLK input pin in the TPU2 is filtered with the same filter clock that is supplied to the channels. This control bit is write once after reset.

0 = Uses fixed four-clock filter

1 = T2CLK input pin filtered with same filter clock that is supplied to the channels.

DTPU — Disable TPU2 Pins

In the TPU2, when the disable TPU2 control pin is asserted, pin TP15 is configured as an input disable pin. When the TP15 pin value is zero, all TPU2 output pins are three-stated, regardless of the pins function. The input is not synchronized. This control bit is write once after reset.

0 = TP15 functions as normal TPU channel.

1 = TP15 pin configured as output disable pin. When TP15 pin is low, all TPU2 output pins are in a high-impedance state, regardless of the pin function.

2.2 Interrupts

The CPU services interrupt requests from peripherals. The peripherals may be located on the same chip as the CPU, or may be off chip. A priority scheme is implemented to prioritize all system peripherals, both on and off chip.

2.2.1 Interrupt Levels

The priority scheme that CPU16-based and CPU32-based MCUs use is based on the 68000 family priority scheme. The CPU16 and CPU32 contain a three-bit interrupt priority mask. This mask is located in the condition code register in the CPU16 and in the status register in the CPU32.

The CPU compares the level of each interrupt request it receives with the mask value. Interrupt request levels greater than the mask are accepted; interrupt request levels less than or equal to the mask are ignored. The only exception to the rule is the non-maskable level seven interrupt request, which is accepted and serviced even if the CPU interrupt mask is seven.

All on-chip peripherals are assigned an interrupt request level from zero to seven. Seven is the highest priority, one is the lowest, and zero disables any interrupt requests. The channel interrupt request level (CIRL) in the TPU interrupt configuration register (TICR) contains the request level associated with TPU interrupts.

2.2.2 Interrupt Arbitration

The same interrupt priority level can be assigned to more than one module. For example, the TPU and the QSM can both be assigned interrupt level five. If both the TPU and the QSM interrupt the CPU simultaneously, then the interrupt arbitration (IARB) fields in the respective module configuration registers determine which module is serviced first.

The IARB field is essentially a second-level priority in case of a tie. Each module that has an interrupt priority level also has an IARB field. Each module must be assigned a unique non-zero IARB value, or operation is undefined when interrupts with the same priority level are issued simultaneously.

IARB fields contain four bits. An IARB value of %1111 is the highest arbitration priority, %0001 is the lowest, and %0000 disables interrupt arbitration. Whereas zero in the interrupt priority level field disables a module from requesting an interrupt, a zero in the IARB field disables a module from acknowledging its interrupt request. If a module with a non-zero interrupt priority field and a zero IARB field requests an interrupt, the CPU sees a spurious interrupt, because the module requesting the interrupt service never confirms that it made the request. The IARB field for the TPU is located in the TPUM-CR.

2.2.3 Interrupt Vectors

The system designer must make sure the CPU knows where to find the service routine for each type of interrupt. The channel interrupt base vector (CIBV) determines where to find the 16 TPU service routines, one for each of the 16 TPU channels. CIBV is the

upper nibble of a byte-size vector number; the lower nibble is the channel number itself. CIBV should contain an unreserved vector number. For example, if CIBV contains \$8, the vector number for a channel 0 interrupt is \$80, the vector number for a channel 1 interrupt is \$81, and so on to \$8F for channel 15. The TPU passes the appropriate vector number to the CPU when it acknowledges its interrupt request.

The system designer must set up the vector table. Refer to the *CPU16 Reference Manual* (CPU16RM/AD) or the *CPU32 Reference Manual* (CPU32RM/AD) for additional information on the vector table.

2.2.4 Enabling Interrupts

The CPU can mask interrupts from individual channels in the channel interrupt enable register (CIER). A zero in a bit field masks the interrupt from a specific channel; a one enables the channel interrupt. If a channel interrupt is masked, the channel interrupt status register (CISR) can be polled to see if an interrupt request is pending. The CISR is the only TPU register that can be accessed by individual byte. This allows CPU32 bit test instructions, which only work on byte accesses, to be used for ease in polling.

To clear a status flag, read the CISR with the bit set, and then write a zero to the appropriate bit.

2.2.5 Development Support and Test Registers

The following registers are used for custom microcode development or for factory test. Describing the use of the registers is beyond the scope of this manual. Refer to TPU-MASMREF/D1, *Time Processor Unit Programmer's Reference Manual* for information on modifying existing time functions or developing microcoded functions. In addition, refer to Motorola Programming Note TPUPN00/D, *Using the TPU Function Library and TPU Emulation Mode*. Register descriptions are provided in **APPENDIX B MEMORY MAP AND REGISTERS**.

TCR — Test Configuration Register	####E02
The TCR is used for factory test only.	
DSCR — Development Support Control Register	####E04
DSSR — Development Support Status Register	####E06
LR — Link Register	####E22
SGLR — Service Grant Latch Register	####E24
DCNR — Decoded Channel Number Register	####E28

2.2.6 Channel Interrupt Registers

CIER — Channel Interrupt Enable Register

####E0A

15	14	13	12	11	10	9	8	7	6	5	4	3	2	1	0
CH 15	CH 14	CH 13	CH 12	CH 11	CH 10	CH 9	CH 8	CH 7	CH 6	CH 5	CH 4	CH 3	CH 2	CH 1	CH 0
RESET:															
0	0	0	0	0	0	0	0	0	0	0	0	0	0	0	0

CH[15:0] — Channel Interrupt Enable/Disable

0 = Channel interrupts disabled

1 = Channel interrupts enabled

CISR — Channel Interrupt Status Register

####E20

15	14	13	12	11	10	9	8	7	6	5	4	3	2	1	0
CH 15	CH 14	CH 13	CH 12	CH 11	CH 10	CH 9	CH 8	CH 7	CH 6	CH 5	CH 4	CH 3	CH 2	CH 1	CH 0
RESET:															
0	0	0	0	0	0	0	0	0	0	0	0	0	0	0	0

CH[15:0] — Channel Interrupt Status Bit

0 = Channel interrupt not asserted

1 = Channel interrupt asserted

TICR — TPU Interrupt Configuration Register

####E08

15	14	13	12	11	10	9	8	7	6	5	4	3	2	1	0
0	0	0	0	0	CIRL			CIBV				0	0	0	0
RESET:															
0	0	0	0	0	0	0	0	0	0	0	0	0	0	0	0

CIRL — Channel Interrupt Request Level

This three-bit encoded field specifies the interrupt request level for all channels. Level seven for this field indicates a non-maskable interrupt; level zero indicates that all channel interrupts are disabled.

CIBV — Channel Interrupt Base Vector

The TPU is assigned 16 unique interrupt vector numbers, one vector number for each channel. The CIBV field specifies the most significant nibble of all 16 TPU channel interrupt vector numbers. The lower nibble of the TPU interrupt vector number is determined by the channel number on which the interrupt occurs.

2.3 Channel Function Select Registers

Each 4-bit field within the channel function select registers specifies one of up to 16 time functions to be executed on the corresponding channel. Numbers for predefined functions in both TPU ROM mask sets currently in production are found in **Tables A-1** and **A-2**. Channel function select registers reside in supervisor data space.

CFSR0 — Channel Function Select Register 0 **\$\$\$E0C**

15	14	13	12	11	10	9	8	7	6	5	4	3	2	1	0
CHANNEL 15				CHANNEL 14				CHANNEL 13				CHANNEL 12			

RESET:

0	0	0	0	0	0	0	0	0	0	0	0	0	0	0	0
---	---	---	---	---	---	---	---	---	---	---	---	---	---	---	---

CFSR1 — Channel Function Select Register 1 **\$\$\$E0E**

15	14	13	12	11	10	9	8	7	6	5	4	3	2	1	0
CHANNEL 11				CHANNEL 10				CHANNEL 9				CHANNEL 8			

RESET:

0	0	0	0	0	0	0	0	0	0	0	0	0	0	0	0
---	---	---	---	---	---	---	---	---	---	---	---	---	---	---	---

CFSR2 — Channel Function Select Register 2 **\$\$\$E10**

15	14	13	12	11	10	9	8	7	6	5	4	3	2	1	0
CHANNEL 7				CHANNEL 6				CHANNEL 5				CHANNEL 4			

RESET:

0	0	0	0	0	0	0	0	0	0	0	0	0	0	0	0
---	---	---	---	---	---	---	---	---	---	---	---	---	---	---	---

CFSR3 — Channel Function Select Register 3 **\$\$\$E12**

15	14	13	12	11	10	9	8	7	6	5	4	3	2	1	0
CHANNEL 3				CHANNEL 2				CHANNEL 1				CHANNEL 0			

RESET:

0	0	0	0	0	0	0	0	0	0	0	0	0	0	0	0
---	---	---	---	---	---	---	---	---	---	---	---	---	---	---	---

CHANNEL[15:0] — Function to Execute on Corresponding Channel

2.4 Host Sequence Registers

The host sequence field helps specify the operation of the time function selected on a given channel. The meaning of the host sequence bits depends on the time function specified. Refer to **Tables A-1** and **A-2** for a summary of host sequence bits for the predefined functions in the two TPU ROM mask sets currently in production.

The CPU can read or write the host sequence registers, but the TPU can only read them. In systems that support privilege levels, host sequence registers can be assigned to either supervisor or user data space.

HSQR0 — Host Sequence Register 0 **\$\$\$E14**

15	14	13	12	11	10	9	8	7	6	5	4	3	2	1	0
CH 15		CH 14		CH 13		CH 12		CH 11		CH 10		CH 9		CH 8	

RESET:

0	0	0	0	0	0	0	0	0	0	0	0	0	0	0	0
---	---	---	---	---	---	---	---	---	---	---	---	---	---	---	---

HSQR1 — Host Sequence Register 1 **\$\$\$E16**

15	14	13	12	11	10	9	8	7	6	5	4	3	2	1	0
CH 7		CH 6		CH 5		CH 4		CH 3		CH 2		CH 1		CH 0	

RESET:

0	0	0	0	0	0	0	0	0	0	0	0	0	0	0	0
---	---	---	---	---	---	---	---	---	---	---	---	---	---	---	---

CH[15:0] — Host Sequence Bits

2.5 Host Service Request Registers

The host service request field selects the type of host service request for the time function selected on a given channel. The meaning of the host service request bits depends on the time function specified. Refer to **Tables A-1** and **A-2** for a summary of host service bits for the predefined functions in the two TPU ROM mask sets currently in production.

A host service request field with a value of %00 signals the host that no service is being requested on the channel. The host can request service on a channel by writing the corresponding host service request field to one of three non-zero states. The CPU should monitor the host service request register and wait until the TPU microengine clears the service request bits to %00 before changing any parameters or issuing a new service request to the channel.

The host CPU can set bits in the host service request registers but cannot clear them. To issue a host service request, the CPU should set the desired bits. All other bits must be written back as zeros.

In systems that support privilege levels, host service request registers can be assigned to either supervisor or user data space.

HSRR0 — Host Service Request Register 0

####E18

15	14	13	12	11	10	9	8	7	6	5	4	3	2	1	0
CH 15	CH 14	CH 13	CH 12	CH 11	CH 10	CH 9	CH 8								
RESET:															
0	0	0	0	0	0	0	0	0	0	0	0	0	0	0	0

HSRR1 — Host Service Request Register 1

####E1A

15	14	13	12	11	10	9	8	7	6	5	4	3	2	1	0
CH 7	CH 6	CH 5	CH 4	CH 3	CH 2	CH 1	CH 0								
RESET:															
0	0	0	0	0	0	0	0	0	0	0	0	0	0	0	0

CH[15:0] — Host Service Request

2.6 Channel Priority Registers

The channel priority registers (CPR0, CPR1) assign one of three priority levels to a channel or disable the channel. **Table 2-9** indicates the priority assignments.

Table 2-9 Channel Priorities

CHX[1:0]	Service
00	Disabled
01	Low
10	Middle
11	High

Access to the channel priority registers may generate a wait state (one clock delay of data transfer acknowledge assertion). The channel priority registers are accessible only from the supervisor privilege level.

It is possible to change the priority level of or disable a channel dynamically. A disabled channel is never scheduled to be serviced. Service requests that are pending before a channel is disabled or occur while a channel is disabled remain asserted until the channel is serviced. It is recommended to configure a host service request for initialization of a channel before that channel is enabled to active priority.

Refer to **SECTION 3 SCHEDULER** for additional information on channel priorities.

CPR0 — Channel Priority Register 0

####E1C

15	14	13	12	11	10	9	8	7	6	5	4	3	2	1	0
CH 15	CH 14	CH 13	CH 12	CH 11	CH 10	CH 9	CH 8	CH 7	CH 6	CH 5	CH 4	CH 3	CH 2	CH 1	CH 0

RESET:

0 0 0 0 0 0 0 0 0 0 0 0 0 0 0 0

CPR1 — Channel Priority Register 1

####E1C

15	14	13	12	11	10	9	8	7	6	5	4	3	2	1	0
CH 7	CH 6	CH 5	CH 4	CH 3	CH 2	CH 1	CH 0	CH 15	CH 14	CH 13	CH 12	CH 11	CH 10	CH 9	CH 8

RESET:

0 0 0 0 0 0 0 0 0 0 0 0 0 0 0 0

CH[15:0] — Priority Level

2.7 Channel Parameter RAM

The channel parameter RAM is organized as one hundred 16-bit words of RAM. In the TPU, channels 0 to 13 have six parameters; channels 14 and 15 each have eight parameters. In the TPU2, channels 0 through 15 each have eight parameters.

The parameter RAM constitutes a shared work space for communication between the CPU and the TPU and provides data storage for the TPU. The TPU can only access data in the parameter RAM.

The parameters required by each pre-programmed time function in the two TPU mask sets currently in production are provided in **APPENDIX A TPU FUNCTIONS**. Refer to the programming notes for the individual functions for additional information.

2.7.1 Parameter RAM Address Map

Table 2-10 is the address map for the channel parameter registers. Addresses are offsets from the parameter RAM base address. Refer to the appropriate user's manual for the parameter RAM base address for a particular MCU.

Parameter RAM is not initialized during reset. It is assignable to either user or supervisor data space.

Table 2-10 Parameter RAM Address Map

Channel Number	Parameter							
	0	1	2	3	4	5	6	7
0	00	02	04	06	08	0A	0C ¹	0E
1	10	12	14	16	18	1A	1C	1E
2	20	22	24	26	28	2A	2C	2E
3	30	32	34	36	38	3A	3C	3E
4	40	42	44	46	48	4A	4C	4E
5	50	52	54	56	58	5A	5C	5E
6	60	62	64	66	68	6A	6C	6E
7	70	72	74	76	78	7A	7C	7E
8	80	82	84	86	88	8A	8C	8E
9	90	92	94	96	98	9A	9C	9E
10	A0	A2	A4	A6	A8	AA	AC	AE
11	B0	B2	B4	B6	B8	BA	BC	BE
12	C0	C2	C4	C6	C8	CA	CC	CE
13	D0	D2	D4	D6	D8	DA	DC	DE
14	E0	E2	E4	E6	E8	EA	EC	EE
15	F0	F2	F4	F6	F8	FA	FC	FE

NOTES:

1. Shaded areas apply to the TPU2 only.

The TPU shares parameter RAM with the CPU. Parameter RAM may be accessed by only one source at a time; an arbitration scheme prevents simultaneous accesses, allowing eventual access to all requesting sources. Long-word CPU accesses are coherent. The following rules regulate parameter RAM access.

The TPU gives priority to the CPU for parameter RAM accesses under any of the following conditions:

- The TPU has completed accessing the second word of a long-word parameter RAM access.
- The parameter RAM was not accessed during the last arbitration period.
- The CPU is arbitrating for the second word access of a long-word transfer.

The TPU takes priority for parameter RAM accesses under either of the following conditions:

- The CPU has completed a data transfer during the last access; or
- The TPU is arbitrating for the second access of a data transfer. (A data transfer is defined as word or long-word access.) All even multiples of back-to-back word accesses are coherent.

Figure 2-3 and **Figure 2-4** illustrate word accesses by a host, such as a CPU, and word or long-word accesses by the TPU.

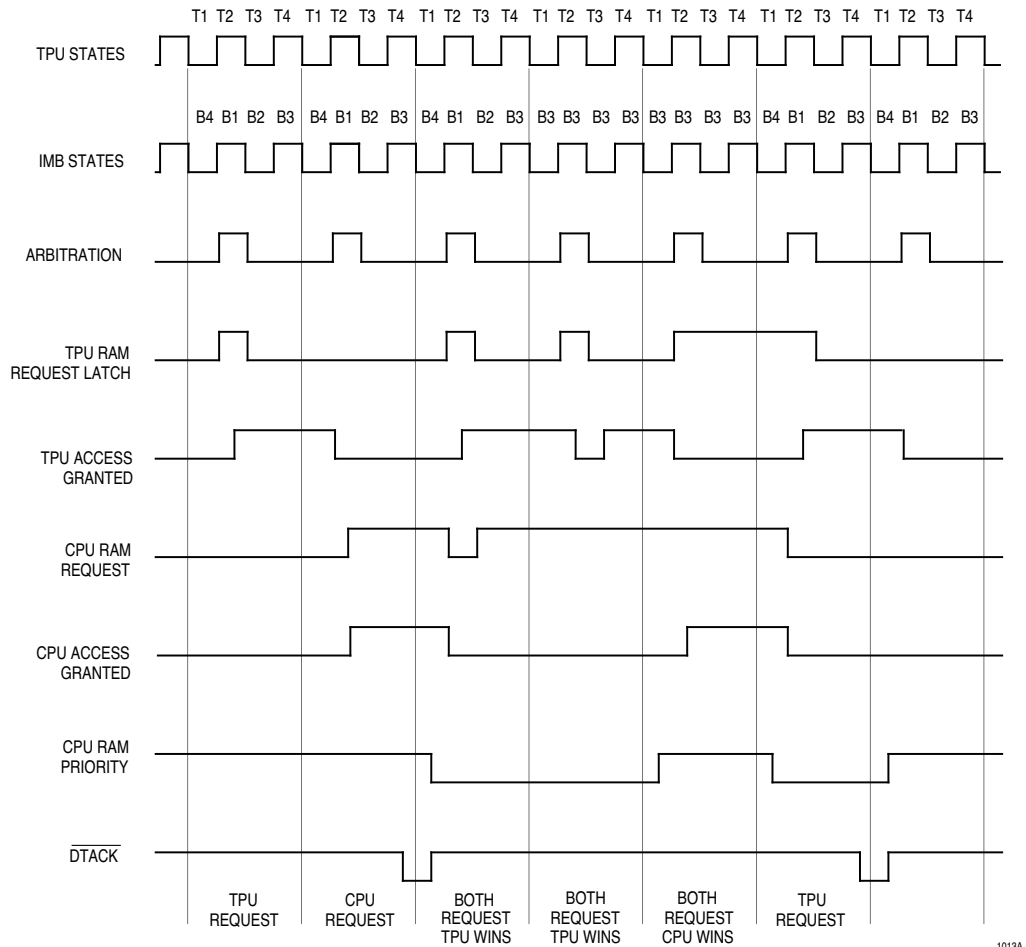

Figure 2-3 Parameter RAM Arbitration Timing, Word Access by Host

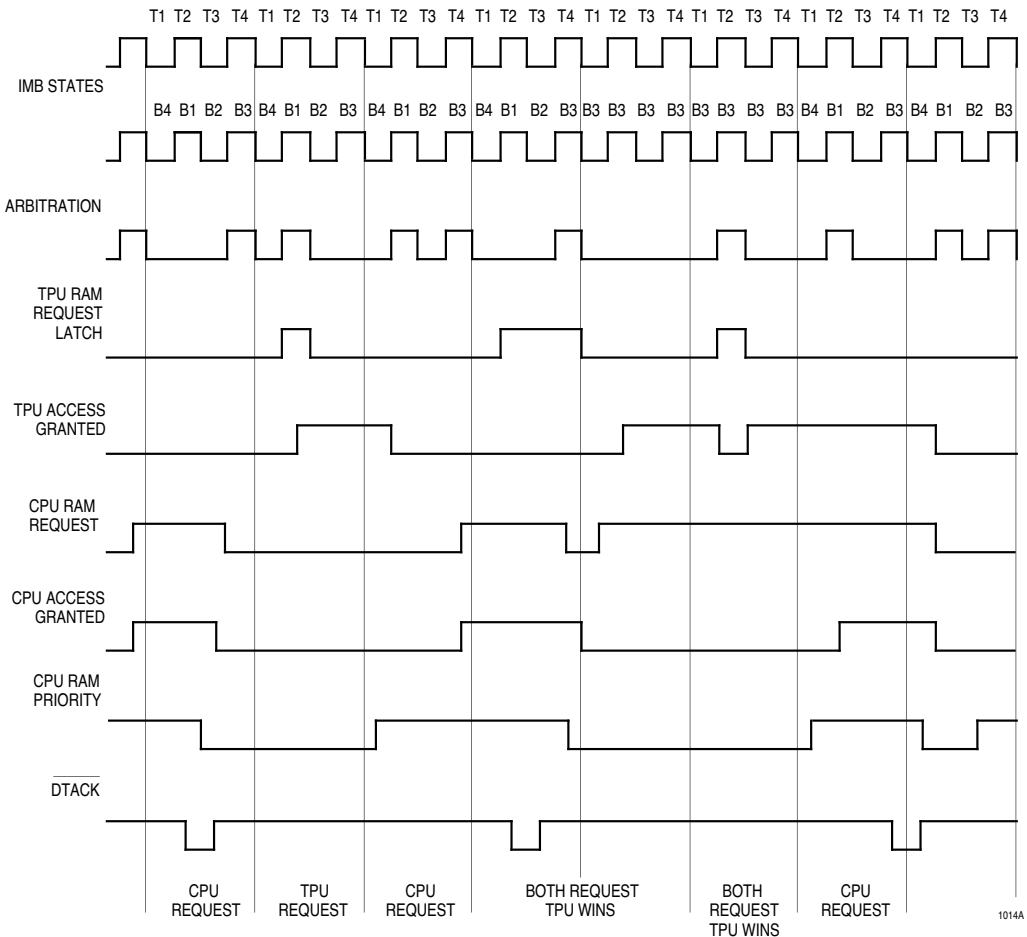

Figure 2-4 Parameter RAM Arbitration Timing, Word or Long-Word Access by TPU

2.8 Configuration Summary

After initial power-on reset, the TPU remains in an idle state, requiring initialization of several registers before any function may begin execution. Configuration procedures are summarized in the following paragraphs, in **Figure 2-5**, and in **2.9 Configuration Examples**.

- Initialize the module configuration register to configure the following:
 - TCR1 selection of clock rate input to prescaler
 - TCR2 selection of either clock or gate function
 - Prescalers for both TCR1 and TCR2
 - Interrupt arbitration identification number for the entire TPU module
 - User/supervisor bit

- Write to the interrupt configuration register to choose the base vector number and interrupt level for the TPU module.
- Write to the channel function select registers to choose the function to be performed by each channel.
- Write to the host sequence registers to choose the variations possible within the function flow.
- Write to parameter RAM for each configured channel.
- Write the host service request registers to initialize the active channels.
- Write to the channel interrupt enable register if interrupts are to be enabled from the appropriate channels.
- Write the channel priority registers last to enable each channel by assigning it a high, middle, or low priority.
- Monitor the host service request registers for completion of initialization.

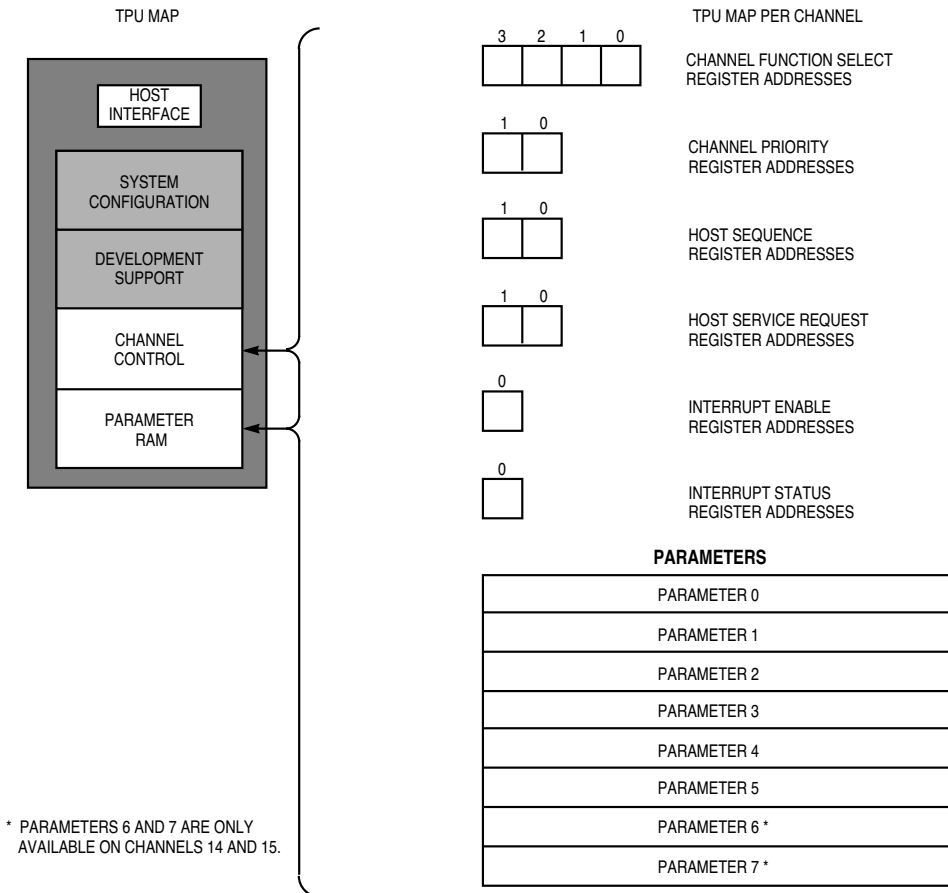

1016A

Figure 2-5 Channel Control and Parameter RAM Configuration

2.9 Configuration Examples

The following examples show how to initialize the TPU for CPU32- and CPU16-based MCUs, respectively.

2.9.1 CPU32 Configuration Example

The following code initializes the TPU to run input transition counter (ITC) on channel 1 and pulse-width modulation (PWM) on channel 0.

```
** Initialize TPU module configuration register and TPU interrupt control register to set up for interrupts from TPU and to set up for a fast clock. **
```

```
ori.w    #$004E, TPUMCR           ;prescale TCR1 by 4, set
                                           ;IARB to $E
move.w   #$0640, ticr             TPU interrupt level = 6,
                                           ;vectors $4X
```

```
** Enable interrupts on channels 0 and 1 only by setting corresponding bits in channel interrupt enable register **
```

```
move.w   #$0003, cier            ;enable interrupts for ch. 0 & 1
```

```
** Choose ITC for channel 1 and PWM for channel 0 by writing to the channel function select register **
```

```
move.w   #$00A9, cfsr3          ;ITC ($A) to ch. 1, PWM (9) to
                                           ;ch. 0
```

```
** Choose options for channel 1 by writing to the host sequence register. Set up parameters for channel 1. **
```

```
move.w   #$0004, hsqr1          ;no link, cont. mode (%01) to
                                           ;ch. 1
move.w   #$0007, chlpar0        ;capture tcr1 on rising edges
move.w   #$000E, chlpar1        ;bank addr pointed to nonexistent
                                           ;addr
                                           ;(if using TPU2, make sure that
                                           ;this address is unused)
move.w   #$000A, chlpar2        ;maxcount - $A for ch. 1
```

```
** Set up parameters for channel 0 **
```

```
move.w   #$0091, ch0par0        ;match TCR1, initialize pin high
move.w   $1000, ch0par2         ;high time = $1000 TCR1 tics
move.w   $2000, ch0par3         ;period = $2000 TCR1 tics
```

```
** Request service to initialize channels 1 and 0 by writing to HSR **
```

```
move.w   #$0006, hsrr1         ;HSR requests to init. ch. 0 and 1
                                           ;(%01 for ch. 1 and %10 for ch. 0)
```

** Assign priorities for channels 1 and 0 by writing to the channel priority register **

```

move.w    #$000B, cpr1           ;ch. 1 = middle priority (%10)
                                           ;ch. 0 = high priority (%11)
move.l    #INT0, $100           ;store starting address of
                                           ;interrupt routines in vector
                                           ;table
andi.w    #$F0FF, sr            ;allow interrupts of level 6
                                           ;and above
ori.w     #$0500, sr

```

** Make sure channels 1 and 0 have been initialized before continuing. (This may not be necessary.) **

```

wait:
move.w    hsr1, d0              ;check host service bits for ch.
                                           ;1 & 0
andi.b    #$0F, d0              ;if host service request bits =
                                           ;00 then channel has been
                                           ;serviced

bne       wait
bra       *                      ;wait here for interrupts to
                                           ;occur

INT0
andi.w    #$fffe, cistr
rte

INT
andi.w    #$fffd, cistr
rte

```

2.9.2 CPU16 Configuration Example

The following code initializes the TPU to run the input transition counter (ITC) function on channel 1 and the pulse-width modulation (PWM) function on channel 0.

```
** Initialize the TPU module configuration register and TPU interrupt control register to set up for interrupts from TPU and to set up for a fast clock. **
```

```
    ldd        TPUMCR
    ord        #$004E
    std        TPUMCR                ;prescale TC1 by 4, set IARB to
                                    ;$E
    ldd        #$0640
    std        ticr                 ;tpu interrupt level = 6, vectors
                                    ;$4X
```

```
** Enable interrupts on channels 0 and 1 only by setting corresponding bits in channel interrupt enable register (CIER) **
```

```
    ldd        #$0003
    std        cier                 ;enable interrupts for ch. 0
                                    ;and 1
```

```
** Choose ITC for channel 1 and PWM for channel 0 by writing to the channel function select register (CFSR) **
```

```
    ldd        #$00A9
    std        cfsr3               ;ITC ($A) to ch. 1, PWM ($9) to
                                    ;ch. 0
```

```
** Choose options for channel 1 by writing to the host sequence register. Set up parameters for channel 1. **
```

```
    ldd        #$0004
    std        hsqr1               ;no link, cont. mode (%01) to
                                    ;ch. 1
    ldd        #$0007
    std        chlpar0             ;capture TC1 on rising edges
    ldd        #$000E
    std        chlpar1             ;bank addr pointed to nonexistent
                                    ;addr (if using TPU2, make sure
                                    ;that this address is unused)
    ldd        #$000A
    std        chlpar2             ;max count = $A for ch. 1
```

```
** Set up parameters for channel 0 **
```

```
    ldd        #$0091
    std        ch0par0             ;match TC1, initialize pin high
    ldd        #$1000
```

```

        std          ch0par2                ;high time = $1000 TCR1 tics
        ldd          #$2000
        std          ch0par3                ;period = $2000 TCR1 tics

** Request service to initialize channels 1 and 0 by writing to the host ser-
vice register **

        ldd          #$0006                ;host service requests to init.
                                           ;ch. 0 & 1
        std          hsrr1                  ;(%01 for ch. 1 and %10 for Ch. 0)

** Assign priorities for channels 1 and 0 by writing to the channel priority
register. **

        ldd          #$000B                ;ch. 1 = middle priority (%10)
        std          cpr1                   ;ch. 0 = high priority (%11)
        ldab        #$00
        tbzk
        ldz          #$0000
        ldd          #INT0                 ;(store starting address of
                                           ;interrupt routines in the vector
                                           ;table)

        std          $80,z
        ldd          #INT1
        std          $82,z
        andp        #$FF1F                ;allow interrupts of level 6 and
                                           ;above
        orp         #$00A0

** Make sure channels 1 and 0 have been initialized before continuing. (This
may not be necessary.) **

wait:
        ldd          hsrr1                 ;check host service bits for ch.
                                           ;1 & 0
        andd        #$000F                ;if host service request bits =
                                           ;00 then channel has been
                                           ;serviced

        bne        wait
        bra        *                       ;wait here for interrupts to
                                           ;occur
INT0    ldd          cisr                   ;interrupt routines
        andd        #$fffe
        std          cisr
        rti
INT1    ldd          cisr
        andd        #$fffd
        std          cisr
        rti

```

SECTION 3 SCHEDULER

Every function is composed of one or more states. A state is constructed of a specific number of microinstructions that cannot be interrupted when executed by the microengine. The intent of every channel is to receive time for state execution (to be serviced). Since one microengine handles up to 16 functions operating concurrently, the function states must be executed serially. The task of the scheduler is to recognize and prioritize the channels needing service and to grant each channel state execution time. The time given to an individual state for execution or service is called a time slot. The duration of a time slot is determined by the number of microinstructions the state contains and, therefore, varies in length.

At any time, an arbitrary number of channels can require service by the microengine. To request service, a channel notifies the scheduler by issuing a service request. A service request, which is any occurrence that asserts the service request latch, has four origins:

1. Match Recognition Service Request
2. Transition Detect Service Request
3. Channel Linking Service Request
4. Host Service Request

Once the scheduler grants a channel a time slot, the service grant latch for that channel is asserted, disabling the service request latch. As a result, the channel may request new service but is not serviced again until all other requesting channels have been serviced. The service grant latch then notifies the scheduler that the channel has been granted a time slot. Likewise, while this latch is asserted, the channel is not granted another time slot for new service.

3.1 Priority Scheme

In order to organize incoming requests and ensure that no channel permanently blocks another channel from receiving a time slot, the scheduler requires a priority scheme. Every channel is assigned one of three priority levels: high, middle, or low. Channel priority assignment is discussed in **2.6 Channel Priority Registers**.

Priority level is determined based on the maximum latency desired for each channel. A channel having a function that requires the most frequent or more immediate service should be allocated a high priority level. To execute service requests, the scheduler addresses two aspects of priority:

- It recognizes that the function of one channel may require data more frequently than the function of another channel.
- It recognizes that all channels need an equal opportunity to be serviced.

The TPU employs a primary and a secondary priority scheme. These two schemes ensure frequent servicing of high-demand functions and ensure a minimum time allocation to all channels requesting service, regardless of their priority level. The primary scheme prioritizes requesting channels that have different priority levels; the secondary scheme prioritizes requesting channels that have the same priority level. The relationship of these schemes is discussed in the following paragraphs.

Initially, a channel requests service and is granted a time slot by the scheduler. Both service request and service grant latches are asserted. If only high-level channels constantly receive service first because of their priority level, middle- and low-level channels would only be serviced by default, i.e., if no high-level channels request service.

To ensure that each priority level receives an opportunity for servicing, every time slot has a fixed priority level that the scheduler honors first. Divided into sets of seven, time slots are numbered from one to seven. **Figure 3-1** illustrates the numbered time slots in sets of seven (fields A and B) and identifies their assigned priority level. The high level has more time slots than the middle and low levels. Out of every seven time slots available, four are assigned to honor high-level channels first, two are assigned to honor middle-level channels first, and one is assigned to honor low-level channels first. Service requests are assigned a time slot for execution. Only one request is serviced per time slot.

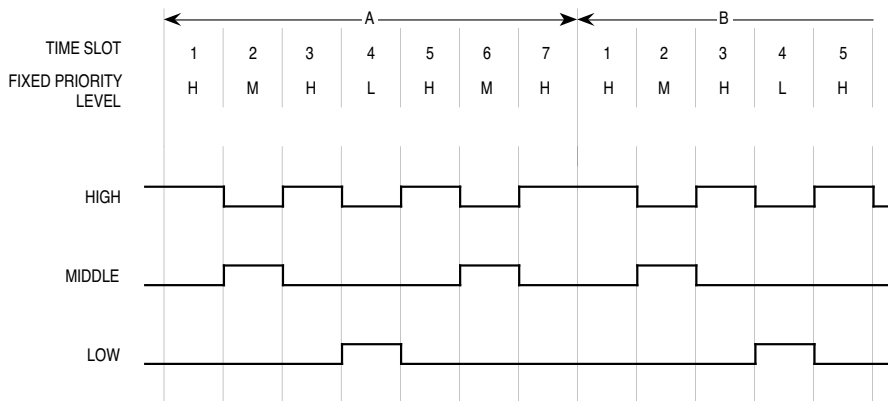

1055A

Figure 3-1 Priority Levels

3.1.1 Primary Scheme — Priority Among Channels on Different Levels

Although time priority is fixed, the servicing priority is not. The primary scheme acknowledges the priority level assigned to a time slot, granting service first to a channel having the same priority. In **Figure 3-1**, time slot one has a high-level assignment; therefore, any high-level channel requesting service is recognized first. However, if no high-level channel requests service, the scheduler recognizes a requesting middle-level channel. If this level has no request, the scheduler continues to the low level. If no requests occur, the scheduler remains in the time slot waiting for any channel to request service. Granting service to a different-level channel is called priority passing. The order of passing, which always gives second priority to a high-level channel, is shown in **Table 3-1**.

Table 3-1 Priority Passing

Assigned Priority Level		Next Priority Level		Next Priority Level
High	→	Middle	→	Low
Middle	→	High	→	Low
Low	→	High	→	Middle

When priority is passed to another level, that level is serviced and the fixed-priority-level sequence is resumed with the next time slot. In field A of **Figure 3-2**, no high-level service requests are present before time slot seven. Thus, time slots one, three, and five, which are normally granted to the high-level channels, are passed to the next privileged level. Time slot one passes priority to a requesting middle-level channel; time slot three passes priority to another middle-level channel, but time slot five passes priority to a low-level channel since no middle-level channel is requesting service.

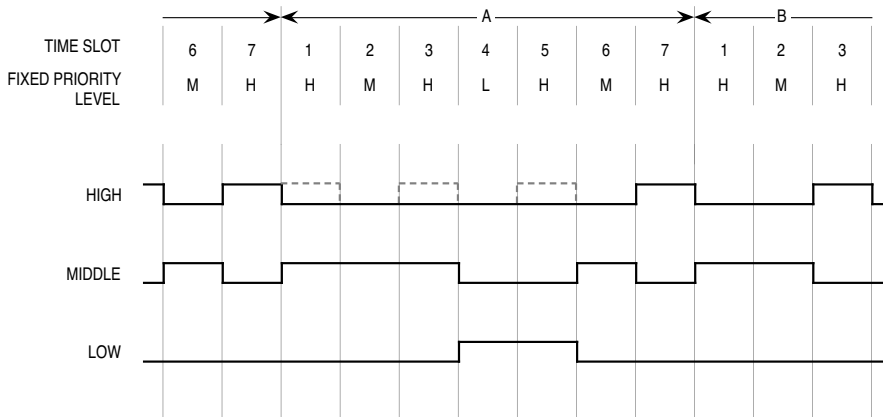

1054A

Figure 3-2 Priority Passing

A two-microcycle (four-clock) delay is introduced after channel service under the following condition: when the service request of a channel is recognized and the channel is the last one on a priority level whose service grant latch is negated. When that channel has been serviced, a two-microcycle delay is introduced. At all other times, service proceeds with the next time slot number without introduction of the delay. This delay mechanism, necessary because of design timing constraints, allows the last channel serviced to be included in the next arbitration for new service on its assigned priority level. This mechanism is necessary for the secondary scheme.

3.1.2 Secondary Scheme — Priority Among Channels on the Same Level

Because channels can randomly request service, inevitably, channels having the same priority level will request service simultaneously. A secondary scheme prioritizes these requests. The scheduler services channels on each of the three priority levels, beginning with the lowest numbered channel on that level. It services all requesting same-level channels before clearing any of them for new service.

3.1.3 Correlation of Primary and Secondary Schemes

The overall priority scheme simultaneously incorporates both primary and secondary schemes. Combining both schemes in the following example conveys their correlation.

1. Having its service request latch asserted, a single high-level channel requires service and is granted time slot one, which has high-level priority (primary scheme). Once serviced, the channel's service grant latch is asserted. Next, the service grant and service request latches are negated, and a two-microcycle delay is introduced.
2. The scheduler proceeds to time slot two, which has middle-level priority; however, no middle-level channel is requesting service. Priority is passed to the high level, but no high-level channel is requesting service; therefore, priority is passed again, and service is granted to the single requesting low-level channel. Once scheduled, this channel's service latches are negated, and a two-microcycle delay is introduced.
3. The scheduler resumes with the fixed-priority sequence on time slot three; however, no channels are requesting service. A two-microcycle delay is introduced, and the scheduler remains at time slot three inserting two-microcycle delays while waiting for requests.
4. Three high-level channels simultaneously request service (this is the secondary scheme). The scheduler finds the lowest numbered high-level channel and assigns it to time slot three, which has high-level priority. This channel's service grant latch is asserted; however, the two remaining high-level channels have asserted service request latches.
5. The scheduler continues to time slot four, which has low priority, and allocates the slot to the lowest numbered low-level channel requesting service (primary scheme). The scheduler notes the still unserved low-level channels and proceeds to time slot five (secondary scheme resumes).
6. The next lowest numbered high-level channel is assigned to time slot five, which has high priority. Noting the one remaining high-level channel, the scheduler continues to time slot six.

7. However, time slot six has middle-level priority, and multiple middle-level channels are requesting service (primary scheme). The slot is allocated to the lowest numbered middle-priority channel (secondary scheme). The remaining middle-priority channels are still unserved, and the scheduler proceeds to time slot seven (secondary scheme resumes).
8. Having high priority, time slot seven is allocated to the third high-priority channel that initially requested service in time slot four. This channel's service grant latch is asserted. The scheduler checks again. All service grant latches are asserted; therefore, all high-priority channels have been allocated execution time. Under this condition, all service request and service grant latches of the high-level serviced channels are negated, and a two-microcycle delay is inserted.
9. The scheduler proceeds to time slot one again.

Notice that in steps six and seven multiple middle and low-priority channels are requesting.

3.2 Time-Slot Latency

Latency is the amount of time between a service request and the beginning of service on that channel. The following factors affect latency:

- Number of active channels
- Number of channels on a priority level
- Number of available time slots on a priority level
- Number of microcycles required to execute a state of a function
- Number of parameter RAM accesses during execution of a function state
- TPU module clock frequency

Each time slot may require a different number of microcycles, depending on the state of a function to be executed. This variation is shown in **Figure 3-3**.

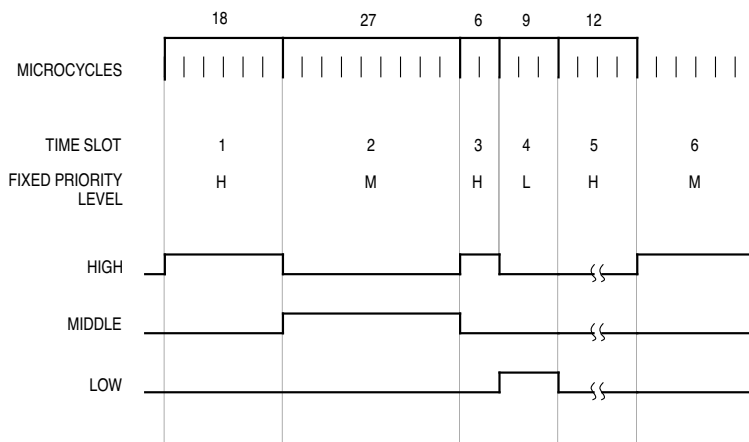

NOTE: THE MICROCYCLE FIGURES ARE ARBITRARY EXAMPLES.

1055A

Figure 3-3 Time-Slot Variation

If the maximum time slot for each channel and the number of RAM accesses by the host CPU are known, the user can determine the maximum latency that will occur for each channel. Procedures for estimating worst-case latency are given in **APPENDIX C ESTIMATING WORST-CASE LATENCY**.

3.3 Disabling a Function

The CPU disables the function operating on a given channel by clearing the channel priority bits to zero. When the CPU disables a function, if the function is currently being serviced, servicing of the function will complete. This means that it is possible for the output level of a channel pin to change even after the priority bits are cleared. For instance, if an output transition is scheduled, the transition will occur even after the channel is disabled.

SECTION 4 TPU EMULATION MODE

In emulation mode, the TPU uses the on-chip TPURAM, normally used by the host CPU, for the control store. Refer to **Figure 4-1**.

Emulation mode gives the user flexibility in selecting a TPU function set. A user can write his or her own functions, download the standard mask set and make changes, or select any combination of functions from the TPU function library. Refer to **4.3 TPU Function Library** for more information.

Any combination of library functions and custom functions can be assembled together and downloaded to the TPURAM, provided the combined size of the functions does not exceed the limit placed on the TPU.

This section provides an overview of TPU emulation mode. For a complete discussion of TPU emulation mode and the TPU function library, refer to Motorola Programming Note TPUPN00/D, *Using the TPU Function Library and TPU Emulation Mode*.

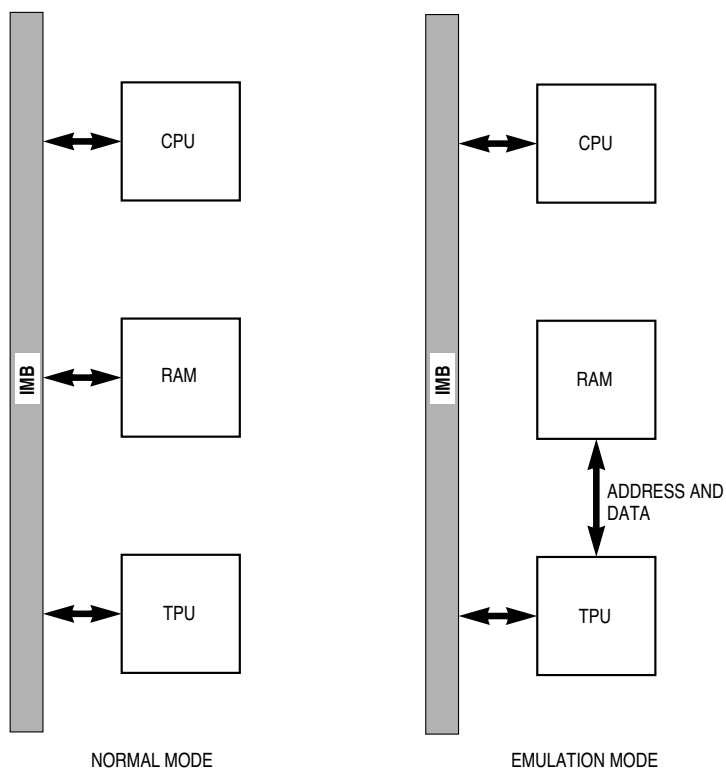

Figure 4-1 On-Chip RAM Configuration

4.1 TPU Control Store Organization

The TPU control store consists of a contiguous 2-Kbyte block of micro-ROM arranged as 512 long words. Refer to **Figure 4-2**.

The TPU2 includes a 4-Kbyte block of micro-ROM and up to eight Kbytes of additional address space. Three configurations of address space are possible. Refer to **Figure 4-3**.

Emulation mode memory is partitioned into a microcode segment and an entry point segment. Each TPU function has 16 word-sized entry points associated with it; there are a total of 128 long words for all 16 possible functions. TPU2 memory can contain multiple entry point segments. Entry point segments are arranged in order by function number (0 to 15). Function numbers are assigned to functions as part of the assembly process. Each entry point includes a vector that forces function execution to begin at a known address. The entry point used at the start of each channel service depends on several conditions.

It is often neither possible nor necessary to fit 16 functions into the control store. When this is the case, the memory area occupied by entry points of unused function numbers is available for extra microcode space. Begin function number assignment with 15 and work down, so that any unused entry point segment is contiguous with the normal microcode segment. This is the most efficient use of the available space. **Figure 4-4** shows unused entry points being used for additional opcode space.

All operations, timing, and conditions that apply to the ROM control store also apply to the RAM when used for emulation.

4.2 Emulation Mode Memory Map

When the TPU enters emulation mode, the TPURAM is dedicated to the TPU and replaces the control store ROM. Most microcontrollers currently available with a TPU have a full two Kbytes of TPURAM, which allows complete emulation of the control store. **Figure 4-2** shows the equivalent host CPU byte addresses that are used to load TPURAM with TPU microcode before invoking emulation mode.

Some Motorola MCUs contain only one Kbyte of TPURAM. With these devices, it is only possible to emulate half the TPU control store. **Figure 4-5** shows emulation memory map and equivalent TPURAM addresses for these devices.

Some Motorola microcontrollers contain TPURAM modules that are larger than the TPU microcode control store. In these devices, only a portion of the TPURAM will be used for TPU emulation, but the entire TPURAM will be removed from the CPU memory map during emulation. The emulation mode memory map will never be larger than the control store map.

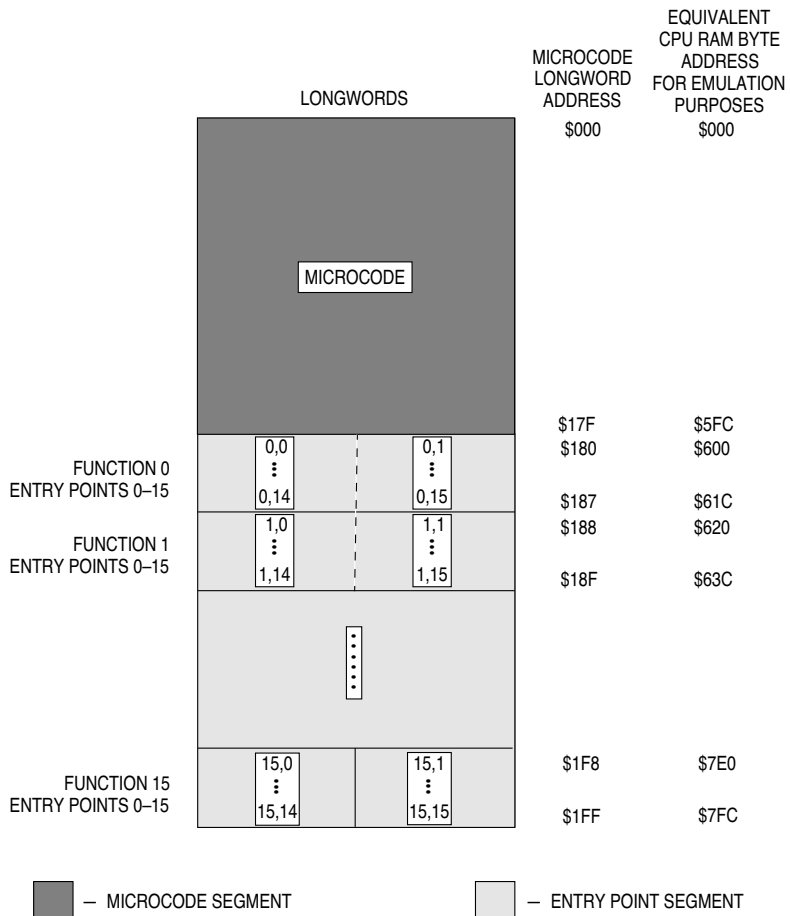

F2

Figure 4-2 TPU Control Store and 2-Kbyte Emulation RAM Map

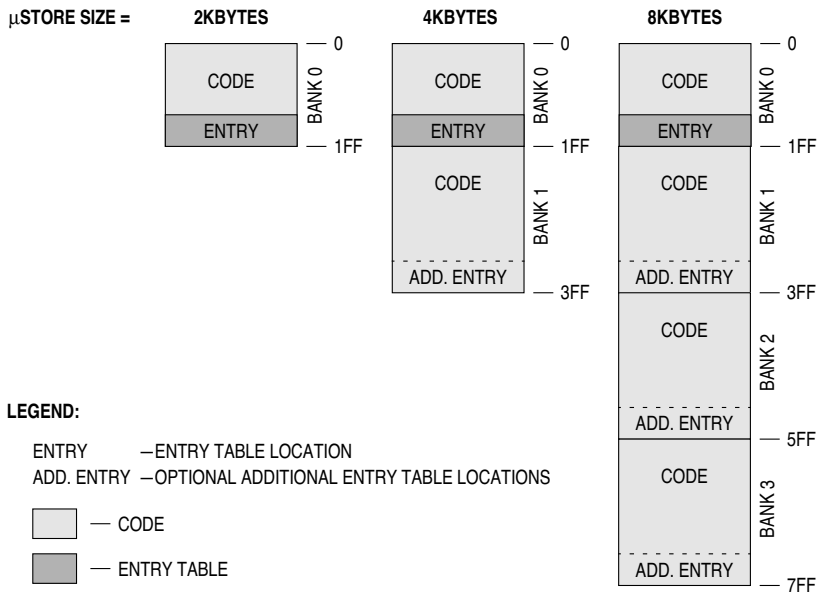

MSTORE CONFIG

Figure 4-3 TPU2 Micro-Store Size Configurations

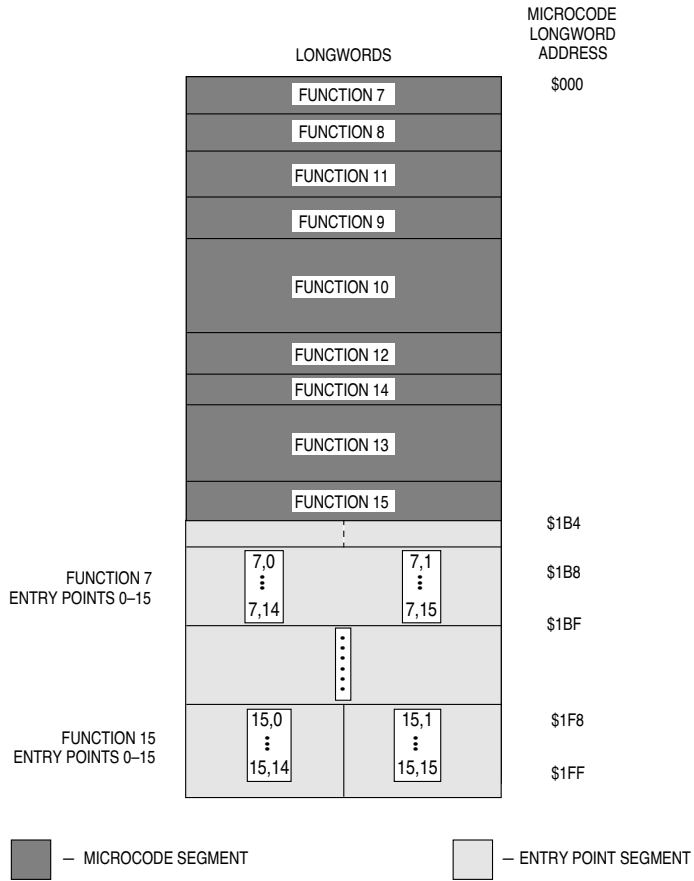

F3

Figure 4-4 Extending Microcode Segment by Means of Unused Entry Points

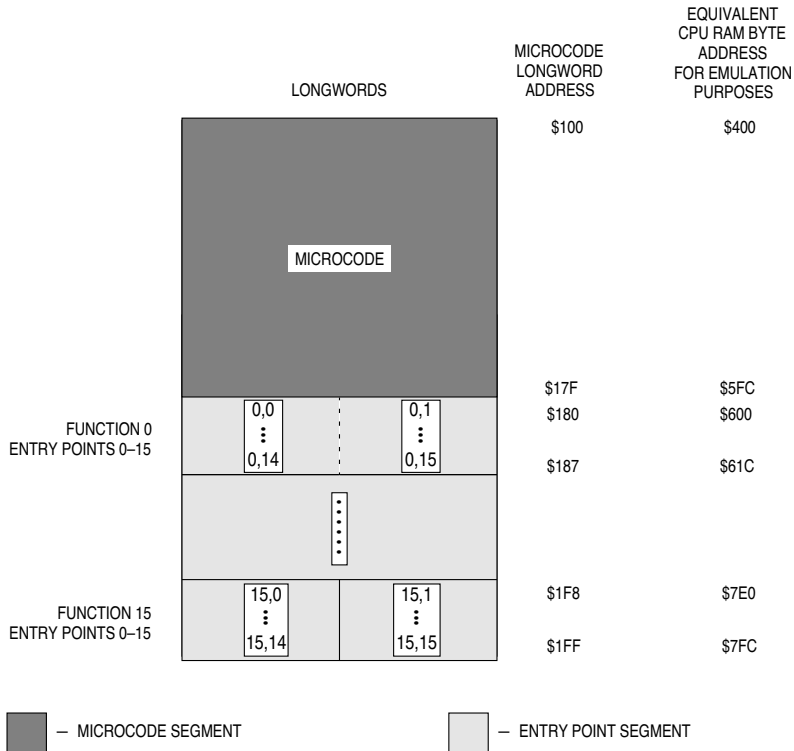

F4

Figure 4-5 1-Kbyte Emulation RAM Memory Map

4.3 TPU Function Library

To support changing TPU application requirements and to allow inclusion of customer-defined TPU functions, Motorola has established a TPU function library. The function library is a collection of TPU functions written for easy assembly in combination with each other or with custom functions. The library currently includes all functions from the standard microcode ROMs and several other functions. Refer to Motorola Programming Note TPUPN00/D, *Using the TPU Function Library and TPU Emulation Mode*, for details on using the function code library and for a list of functions currently available. Other functions are being developed and the list of functions will continue to grow as Motorola responds to requests for new features.

Source code for functions, which is required to combine them into a new set, is available from Motorola (refer to Motorola Programming Note TPUPN00/D, *Using the TPU Function Library and TPU Emulation Mode* for details) or your local Motorola technical representative.

4.4 Emulation Mode Summary

Motorola Programming Note TPUPN00/D, *Using the TPU Function Library and TPU Emulation Mode*, provides detailed instructions on installing and running functions from the function library. Following is a summary of the steps required:

1. Select the desired set of functions and determine that total code size is within the limit (512 long words).
2. Assemble the source code for the desired functions to produce executable code.
3. Configure the on-chip emulation TPURAM by writing to the TPURAM base address register.
4. Load the code into TPURAM.
5. Put the TPU into emulation mode by setting the EMU bit in the TPU module configuration register.

While the TPU is in emulation mode, the TPURAM module is removed from the CPU memory map, and the vacated address space may be allocated to other internal or external peripheral modules.

Once procedures for loading and configuring the TPU for emulation mode operation are completed, the TPU will run the set of newly installed functions as though they were contained in the control store ROM. To run the functions, the CPU must set up control registers and parameter RAM as explained in the documentation for each function. In emulation mode, the functions in microcode ROM are not available to the TPU.

APPENDIX A TPU FUNCTIONS

The following pages provide brief descriptions of the pre-programmed functions in the two TPU mask sets currently in use. For detailed descriptions, refer to the programming note for the individual function. Motorola Programming Note TPUPN00/D, *Using the TPU Function Library and TPU Emulation Mode*, provides a list of available programming notes.

A.1 Mask Set A

Table A-1 gives the function code and lists options for the host sequence bits and the host service request bits for each function in mask set A.

Table A-1 Mask Set A Time Function Encodings

Function Name	Function Code	Host Service Request Code	Host Sequence Code ¹
PPWA Period/Pulse-Width Accumulator	\$F	0 = None 1 = (Not Implemented) 2 = Initialization 3 = (Not Implemented)	0 = 24-Bit Period 1 = 16-Bit Period + Link 2 = 24-Bit Pulse Width 3 = 16-Bit Pulse Width + Link
OC Output Compare	\$E	0 = None 1 = Host-Initiated Pulse Mode 2 = (Not Implemented) 3 = Continuous Pulse Mode	0 = Execute All Functions 1 = Execute All Functions 2 = Only Update TCRn Parameters 3 = Only Update TCRn Parameters
SM Stepper Motor	\$D	0 = None 1 = None 2 = Initialization 3 = Step Request	(None Implemented)
PSP Position-Synchronized Pulse Generator	\$C	0 = None 1 = Immediate Update Request 2 = Initialization 3 = Force Change	0 = Pulse Width Set by Angle 1 = Pulse Width Set by Time 2 = Pulse Width Set by Angle 3 = Pulse Width Set by Time
PMA/PMM Period Measurement with Additional/Missing Transition Detect	\$B	0 = None 1 = Initialization 2 = (Not Implemented) 3 = (Not Implemented)	0 = PMA Bank Mode 1 = PMA Count Mode 2 = PMM Bank Mode 3 = PMM Count Mode
ITC Input Capture/ Input Transition Counter	\$A	0 = None 1 = Initialization 2 = (Not Implemented) 3 = (Not Implemented)	0 = No Link, Single Mode 1 = No Link, Continuous Mode 2 = Link, Single Mode 3 = Link, Continuous Mode
PWM Pulse-Width Modulation	\$9	0 = None 1 = Immediate Update Request 2 = Initialization 3 = (Not Implemented)	(None Implemented)
DIO Discrete Input/Output	\$8	0 = None 1 = Force Output High 2 = Force Output Low 3 = Initialization, Input Specified 3 = Initialization, Periodic Input 3 = Update Pin Status Parameter	0 = Trans Mode – Record Pin on Transition 0 = Trans Mode – Record Pin on Transition 0 = Trans Mode – Record Pin on Transition 1 = Match Mode – Record Pin at MATCH_RATE 2 = Record Pin State on HSR <u>11</u>
SPWM Synchronized Pulse- Width Modulation	\$7	0 = None 1 = (Not Implemented) 2 = Initialization 3 = Immediate Update Request	0 = Mode 0 1 = Mode 1 2 = Mode 2 3 = (Not Implemented)
QDEC Quadrature Decode	\$6	0x = No Action 10 = Read TCR1 11 = Initialize	x0 = Primary Channel x1 = Secondary Channel

NOTES:

1. Host Sequence Code interpretation is determined by the function; some HSQ codes apply to all HSR codes, some to only one, such as Init. See detailed function description for full information.

A.2 Mask Set G

Table A-2 gives the function code and lists options for the host sequence bits and the HSR bits for each function in mask set G.

Table A-2 Mask Set G Time Function Encodings

Function Name	Function Code	Host Service Request Code	Host Sequence Code*
PTA Programmable Time Accumulator	\$F	0 = No host service 1 = No effect 2 = No effect 3 = Initialize function	0 = High time accumulate 1 = Low time accumulate 2 = Period accumulate – rising 3 = Period accumulate – falling
Queued Output Match (QOM)	\$E	0 = No Host Service 1 = Initialize, No Pin Change 2 = Initialize, Pin Low 3 = Initialize, Pin High	0 = Single-shot mode 1 = Loop Mode 2 = Continuous Mode 3 = Continuous Mode
TSM Table Stepper Motor	\$D	0 = No Host Service 1 = Initialize, Pin Low 2 = Initialize, Pin High 3 = Move Request (Master Only)	0 = Rotate PIN_SEQUENCE once between steps, local mode acceleration table 1 = Rotate PIN_SEQUENCE once between steps, split mode acceleration table 2 = Rotate PIN_SEQUENCE twice between steps, local mode acceleration table 3 = Rotate PIN_SEQUENCE twice between steps, split mode acceleration table
FQM Frequency Measurement	\$C	0 = No Host Service 1 = Undefined 2 = Initialize 3 = Undefined	0 = Begin with Falling Edge – Single-Shot Mode 1 = Begin with Falling Edge – Continuous Mode 2 = Begin with Rising Edge – Single-Shot Mode 3 = Begin with Rising Edge – Continuous Mode
UART Asynchronous Receiver/Transmitter	\$B	0 = No Host Service 1 = Not used 2 = Receive 3 = Transmit	0 = No Parity 1 = No Parity 2 = Even Parity 3 = Odd Parity
NITC New Input Transition Counter	\$A	0 = No Host Service 1 = Initialize TCR Mode 2 = Initialize Parameter Mode 3 = Not Used	0 = Single Shot, No Links 1 = Continual, No Links 2 = Single Shot, Links 3 = Continual, Links
COMM Multiphase Motor Commutation	\$9	0 = No host service request 1 = Not used 2 = Initialize or force state 3 = Initialize or force immediate state test	0 = Sensorless match update mode 1 = Sensorless match update mode 2 = Sensorless link update mode 3 = Sensored mode
HALLD	\$8	0 = No host service 1 = Not used 2 = Initialize – two channel mode 3 = Initialize – three channel mode	0 = Channel A 1 = Channel B 2 = Channel B 3 = Channel C (3-channel mode only)
MCPWM Multichannel PWM	\$7	0 = No Host Service 1 = Initialize as Slave (Inverted) 2 = Initialize as Slave (Normal) 3 = Initialize as Master	0 = Edge-Aligned Mode 1 = Slave A Type CA Mode 2 = Slave B Type CA Mode 3 = Slave B Type CA Mode
FQD Fast Quadrature Decode	\$6	0 = No Host Service Request 1 = Not Used 2 = Read TCR1 3 = Initialize	0 = Primary Channel – Normal Mode 1 = Secondary Channel – Normal Mode 2 = Primary Channel – Fast Mode 3 = Secondary Channel – Fast Mode

A.3 CHANNEL CONTROL Parameter

Mask set A functions have a common parameter called CHANNEL_CONTROL. Channel control fields are described in the following paragraphs and summarized in **Table A-3**.

TBS — Time Base/Directionality Selection

The TBS field specifies a channel pin as either input or output, and the time base to be used for match and capture events. Either TCR can be used for the match event or for the input capture event. For example, the match event of the channel may use one TCR as a time base, while the input capture event of the same channel may use the other TCR as a time base.

PAC — Pin Action Control

The PAC field specifies the pin logic response as either a timer channel input or output. For input, PAC specifies the transition edge to be detected, resulting in assertion of the transition detect latch. For output, PAC specifies the logic level to be output to the pin due to assertion of the match recognition latch.

PSC — Pin State Control (PSC)

The PSC field forces the output logic level of the pin directly, while not affecting the pin action control latches or the output level specified by the state of the pin action control latches.

Table A-3 CHANNEL CONTROL Options

TBS				PAC			PSC		Action	
8	7	6	5	4	3	2	1	0	Input	Output
							0	0	—	Force Pin as Specified by PAC Latches
							0	1	—	Force Pin High
							1	0	—	Force Pin Low
							1	1	—	Do Not Force Any State
				0	0	0			Do Not Detect Transition	Do Not Change Pin State on Match
				0	0	1			Detect Rising Edge	High on Match
				0	1	0			Detect Falling Edge	Low on Match
				0	1	1			Detect Either Edge	Toggle on Match
				1	x	x			Do Not Change PAC	Do Not Change PAC
0	0	x	x						Input Channel	
0	0	0	0						Capture TCR1, Match TCR1	—
0	0	0	1						Capture TCR1, Match TCR2	—
0	0	1	0						Capture TCR2, Match TCR1	—
0	0	1	1						Capture TCR2, Match TCR2	—
0	1	x	x							Output Channel
0	1	0	0						—	Capture TCR1, Match TCR1
0	1	0	1						—	Capture TCR2, Match TCR2
0	1	1	0						—	Capture TCR2, Match TCR1
0	1	1	1						—	Capture TCR2, Match TCR2
1	x	x	x						Do Not Change TBS	Do Not Change TBS

A.4 Period/Pulse-Width Accumulator (PPWA)

The period/pulse-width accumulator (PPWA) algorithm accumulates a 16-bit or 24-bit sum of either the period or the pulse width of an input signal over a programmable number of periods or pulses (from 1 to 255). After an accumulation period, the algorithm can generate a link to a sequential block of up to eight channels. The user specifies a starting channel of the block and number of channels within the block. Generation of links depends on the mode of operation.

Any channel can be used to measure an accumulated number of periods of an input signal. A maximum of 24 bits can be used for the accumulation parameter. From 1 to 255 period measurements can be made and summed with the previous measurement(s) before the TPU interrupts the CPU, allowing instantaneous or average frequency measurement, and the latest complete accumulation (over the programmed number of periods).

The pulse width (high-time portion) of an input signal can be measured (up to 24 bits) and added to a previous measurement over a programmable number of periods (1 to 255). This provides an instantaneous or average pulse-width measurement capability, allowing the latest complete accumulation (over the specified number of periods) to always be available in a parameter.

By using the output compare function in conjunction with PPWA, an output signal can be generated that is proportional to a specified input signal. The ratio of the input and output frequency is programmable. One or more output signals with different frequencies, yet proportional and synchronized to a single input signal, can be generated on separate channels.

Figure A-1 shows the host interface areas and parameter RAM for the PPWA function.

CONTROL BITS

	NAME	OPTIONS	ADDRESSES
3 2 1 0 <input type="checkbox"/> <input type="checkbox"/> <input type="checkbox"/> <input type="checkbox"/>	CHANNEL FUNCTION SELECT	PPWA FUNCTION NUMBER (ASSIGNED DURING MICRO-CODE ASSEMBLY)	###E0C-###E12
1 0 <input type="checkbox"/> <input type="checkbox"/>	CHANNEL PRIORITY	00 – CHANNEL DISABLED 01 – LOW PRIORITY 10 – MEDIUM PRIORITY 11 – HIGH PRIORITY	###E1C-###E1E
1 0 <input type="checkbox"/> <input type="checkbox"/>	HOST SEQUENCE BITS	00 – ACCUMULATE 24-BIT PERIODS, NO LINKS 01 – ACCUMULATE 16-BIT PERIODS, LINKS 10 – ACCUMULATE 24-BIT PULSE WIDTHS, NO LINKS 11 – ACCUMULATE 16-BIT PULSE WIDTHS, LINKS	###E14-###E16
1 0 <input type="checkbox"/> <input type="checkbox"/>	HOST SERVICE BITS	00 – NOT USED 01 – NOT USED 10 – INITIALIZE 11 – NOT USED	###E18-###E1A
0 <input type="checkbox"/>	INTERRUPT ENABLE	0 – INTERRUPT NOT ASSERTED 1 – INTERRUPT ASSERTED	###E0A
0 <input checked="" type="checkbox"/>	INTERRUPT STATUS		###E20

PARAMETER RAM

	15	14	13	12	11	10	9	8	7	6	5	4	3	2	1	0
###FW0	START_LINK_CHANNEL				LINK_CHANNEL_COUNT				CHANNEL_CONTROL							
###FW2	MAX_COUNT								PERIOD_COUNT							
###FW4	LAST_ACCUM															
###FW6	ACCUM															
###FW8	ACCUM_RATE								PPWA_UB							
###FWA	PPWA_LW															
###FWC																
###FWE																

<input type="checkbox"/>	= WRITTEN BY CPU	<input checked="" type="checkbox"/>	= WRITTEN BY CPU AND TPU
<input checked="" type="checkbox"/>	= WRITTEN BY TPU	<input type="checkbox"/>	= UNUSED PARAMETERS

W = CHANNEL NUMBER

NOTES:

1. THE TPU DOES NOT CHECK THE VALUE OF LINK_CHANNEL_COUNT. IF THIS PARAMETER IS **NOT** > 0 AND ≤ 8, RESULTS ARE UNPREDICTABLE.
2. MAX_COUNT MAY BE WRITTEN AT ANY TIME BY THE HOST CPU, BUT IF THE VALUE WRITTEN IS ≤ PERIOD_COUNT, A PERIOD OR PULSE-WIDTH ACCUMULATION IS TERMINATED. IF THIS HAPPENS, THE NUMBER OF PERIODS OVER WHICH THE ACCUMULATION IS DONE WILL NOT CORRESPOND TO MAX_COUNT.

1049A

Figure A-1 PPWA Parameters

A.5 Output Compare (OC)

The output compare (OC) function generates a rising edge, falling edge, or a toggle of the previous edge in one of three ways:

1. Immediately upon CPU initiation, thereby generating a pulse with a length equal to a programmable delay time.
2. At a programmable delay time from a user-specified time.
3. Continuously. Upon receiving a link from a channel, OC references, without CPU interaction, a specifiable period and calculates an offset:

$$\text{Offset} = \text{Period} \times \text{Ratio}$$

where RATIO is a parameter supplied by the user.

This algorithm generates a 50% duty-cycle continuous square wave with each high/low time equal to the calculated OFFSET. Due to offset calculation, there is an initial link time before continuous pulse generation begins.

Figure A-2 shows the host interface areas and parameter RAM for the OC function.

CONTROL BITS

	NAME	OPTIONS	ADDRESSES
3 2 1 0 <input type="checkbox"/> <input type="checkbox"/> <input type="checkbox"/> <input type="checkbox"/>	CHANNEL FUNCTION SELECT	OC FUNCTION NUMBER (ASSIGNED DURING MICRO-CODE ASSEMBLY)	###E0C-###E12
1 0 <input type="checkbox"/> <input type="checkbox"/>	CHANNEL PRIORITY	00 – CHANNEL DISABLED 01 – LOW PRIORITY 10 – MEDIUM PRIORITY 11 – HIGH PRIORITY	###E1C-###E1E
1 0 <input type="checkbox"/> <input type="checkbox"/>	HOST SEQUENCE BITS	0x – MATCHES AND PULSES SCHEDULED 1x – ONLY READ TCR1, TCR2	###E14-###E16
1 0 <input type="checkbox"/> <input type="checkbox"/>	HOST SERVICE BITS	00 – NO HOST SERVICE REQUEST 01 – HOST-INITIATED PULSE 10 – NOT USED 11 – INITIALIZE, CONTINUOUS PULSES	###E18-###E1A
0 <input type="checkbox"/>	INTERRUPT ENABLE	0 – INTERRUPT NOT ASSERTED 1 – INTERRUPT ASSERTED	###E0A
0 <input checked="" type="checkbox"/>	INTERRUPT STATUS		###E20

PARAMETER RAM

	15	14	13	12	11	10	9	8	7	6	5	4	3	2	1	0
###FW0									CHANNEL_CONTROL							
###FW2	OFFSET															
###FW4	RATIO							REF_ADDR1					0			
###FW6	REF_ADDR2					0		REF_ADDR3							0	
###FW8	REF_TIME															
###FWA	ACTUAL_MATCH_TIME															
###FEC	TCR1															
###FEE	TCR2															

= WRITTEN BY CPU = WRITTEN BY CPU AND TPU
 = WRITTEN BY TPU = UNUSED PARAMETERS
 W = CHANNEL NUMBER

1024A

Figure A-2 OC Parameters

A.6 Stepper Motor (SM) Control

The stepper motor (SM) control algorithm provides for linear acceleration and deceleration control of a stepper motor with a programmable number of step rates of up to 14. Any group of channels, up to eight, can be programmed to generate the control logic necessary to drive a stepper motor.

The time period between steps (P) is defined as:

$$P(r) = K1 - K2 \times r$$

where r is the current step rate (1–14), and K1 and K2 are supplied as parameters.

After providing the desired step position in a 16-bit parameter, the CPU issues a step request. Next, the TPU steps the motor to the desired position through an acceleration/deceleration profile defined by parameters. The parameter indicating the desired position can be changed by the CPU while the TPU is stepping the motor. This algorithm changes the control state every time a new step command is received.

A 16-bit parameter initialized by the CPU for each channel defines the output state of the associated pin. The bit pattern written by the CPU defines the method of stepping, such as full stepping or half stepping. With each transition, the 16-bit parameter rotates one bit. The period of each transition is defined by the programmed step rate.

Figures A-3 and **A-4** show the host interface areas and parameter RAM for the SM function.

CONTROL BITS

	NAME	OPTIONS	ADDRESSES								
<table border="1" style="display: inline-table; border-collapse: collapse;"> <tr> <td style="padding: 2px;">3</td> <td style="padding: 2px;">2</td> <td style="padding: 2px;">1</td> <td style="padding: 2px;">0</td> </tr> <tr> <td style="width: 15px; height: 15px;"></td> <td style="width: 15px; height: 15px;"></td> <td style="width: 15px; height: 15px;"></td> <td style="width: 15px; height: 15px;"></td> </tr> </table>	3	2	1	0					CHANNEL FUNCTION SELECT	SM FUNCTION NUMBER (ASSIGNED DURING MICRO-CODE ASSEMBLY)	\$###E0C-\$###E12
3	2	1	0								
<table border="1" style="display: inline-table; border-collapse: collapse;"> <tr> <td style="padding: 2px;">1</td> <td style="padding: 2px;">0</td> </tr> <tr> <td style="width: 15px; height: 15px;"></td> <td style="width: 15px; height: 15px;"></td> </tr> </table>	1	0			CHANNEL PRIORITY	00 – CHANNEL DISABLED 01 – LOW PRIORITY 10 – MEDIUM PRIORITY 11 – HIGH PRIORITY	\$###E1C-\$###E1E				
1	0										
<table border="1" style="display: inline-table; border-collapse: collapse;"> <tr> <td style="padding: 2px;">1</td> <td style="padding: 2px;">0</td> </tr> <tr> <td style="width: 15px; height: 15px;"></td> <td style="width: 15px; height: 15px;"></td> </tr> </table>	1	0			HOST SEQUENCE BITS	xx – NOT USED	\$###E14-\$###E16				
1	0										
<table border="1" style="display: inline-table; border-collapse: collapse;"> <tr> <td style="padding: 2px;">1</td> <td style="padding: 2px;">0</td> </tr> <tr> <td style="width: 15px; height: 15px;"></td> <td style="width: 15px; height: 15px;"></td> </tr> </table>	1	0			HOST SERVICE BITS	00 – NO HOST SERVICE REQUEST 01 – NOT USED 10 – INITIALIZE 11 – STEP REQUEST (PRIMARY CHANNEL ONLY)	\$###E18-\$###E1A				
1	0										
<table border="1" style="display: inline-table; border-collapse: collapse;"> <tr> <td style="padding: 2px;">0</td> </tr> <tr> <td style="width: 15px; height: 15px;"></td> </tr> </table>	0		INTERRUPT ENABLE	0 – INTERRUPT NOT ASSERTED 1 – INTERRUPT ASSERTED	\$###E0A						
0											
<table border="1" style="display: inline-table; border-collapse: collapse;"> <tr> <td style="padding: 2px;">0</td> </tr> <tr> <td style="width: 15px; height: 15px;"></td> </tr> </table>	0		INTERRUPT STATUS		\$###E20						
0											

PARAMETER RAM (PRIMARY CHANNEL)

	15	14	13	12	11	10	9	8	7	6	5	4	3	2	1	0
\$###FW0									CHANNEL_CONTROL							
\$###FW2	PIN_CONTROL															
\$###FW4	CURRENT_POSITION															
\$###FW6	DESIRED_POSITION															
\$###FW8	0 0 0 0				MOD_CNT				0 0 0 0				NEXT_STEP_RATE			
\$###FWA	0 0 0 0				STEP_RATE_CNT				0 0 0 0				LAST_SEC_CHN			
\$###FWC																
\$###FWE																

<table border="1" style="display: inline-table; border-collapse: collapse; margin-right: 10px;"> <tr><td style="width: 15px; height: 15px;"></td></tr> </table> = WRITTEN BY CPU		<table border="1" style="display: inline-table; border-collapse: collapse; margin-right: 10px;"> <tr><td style="width: 15px; height: 15px; background-color: #333333;"></td></tr> </table> = WRITTEN BY CPU AND TPU	
<table border="1" style="display: inline-table; border-collapse: collapse; margin-right: 10px;"> <tr><td style="width: 15px; height: 15px; background-color: #999999;"></td></tr> </table> = WRITTEN BY TPU		<table border="1" style="display: inline-table; border-collapse: collapse; margin-right: 10px;"> <tr><td style="width: 15px; height: 15px; background-color: #cccccc;"></td></tr> </table> = UNUSED PARAMETERS	

W = CHANNEL NUMBER

1046A-1

Figure A-3 SM Parameters, Part 1 of 2

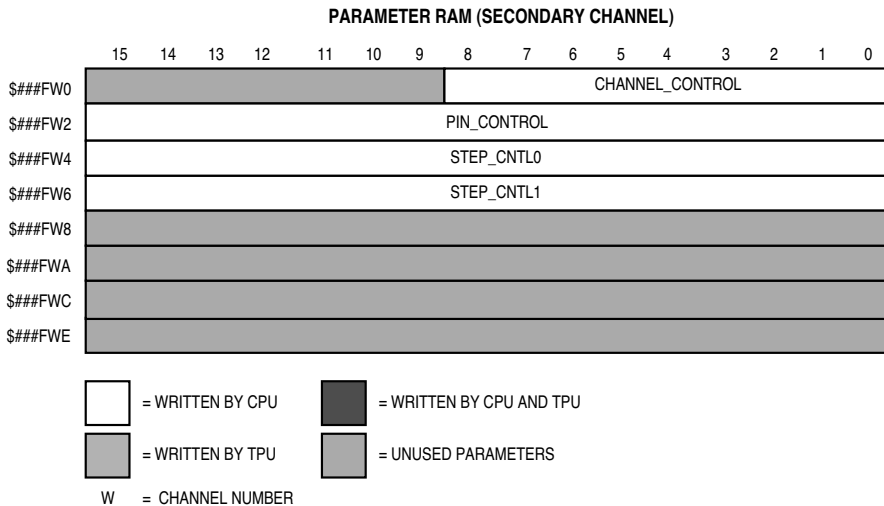

1046A-2

Figure A-4 SM Parameters, Part 2 of 2

A.7 Position-Synchronized Pulse Generator (PSP)

The PSP function generates pulses of variable length at specified “angles.” Angle clock period is measured (in TCR1 clocks) using the PMA/PMM function on another channel.

Any channel of the TPU can generate an output transition or pulse, which is a projection in time based on a reference period previously calculated on another channel. Both TCRs are used in this algorithm: TCR1 is internally clocked, and TCR2 is clocked by a position indicator in the user's device. An example of a TCR2 clock source is a sensor that detects special teeth on the flywheel of an automobile using PMA or PMM. The teeth are placed at known degrees of engine rotation; hence, TCR2 is a coarse representation of engine degrees (for example, each count represents some number of degrees).

Up to 15 position-synchronized pulse generator (PSP) function channels can operate with a single input reference channel executing a PMA or PMM input function. The input channel measures and stores the time period between the flywheel teeth and resets TCR2 when the engine reaches a reference position. The output channel uses the period calculated by the input channel to project output transitions at specific engine degrees. Because the flywheel teeth might be 30 or more degrees apart, a fractional multiplication operation resolves down to the desired degrees. Two modes of operation allow pulse length to be determined either by angular position or by time.

Figure A-5 shows the host interface areas and parameter RAM for the PSP function.

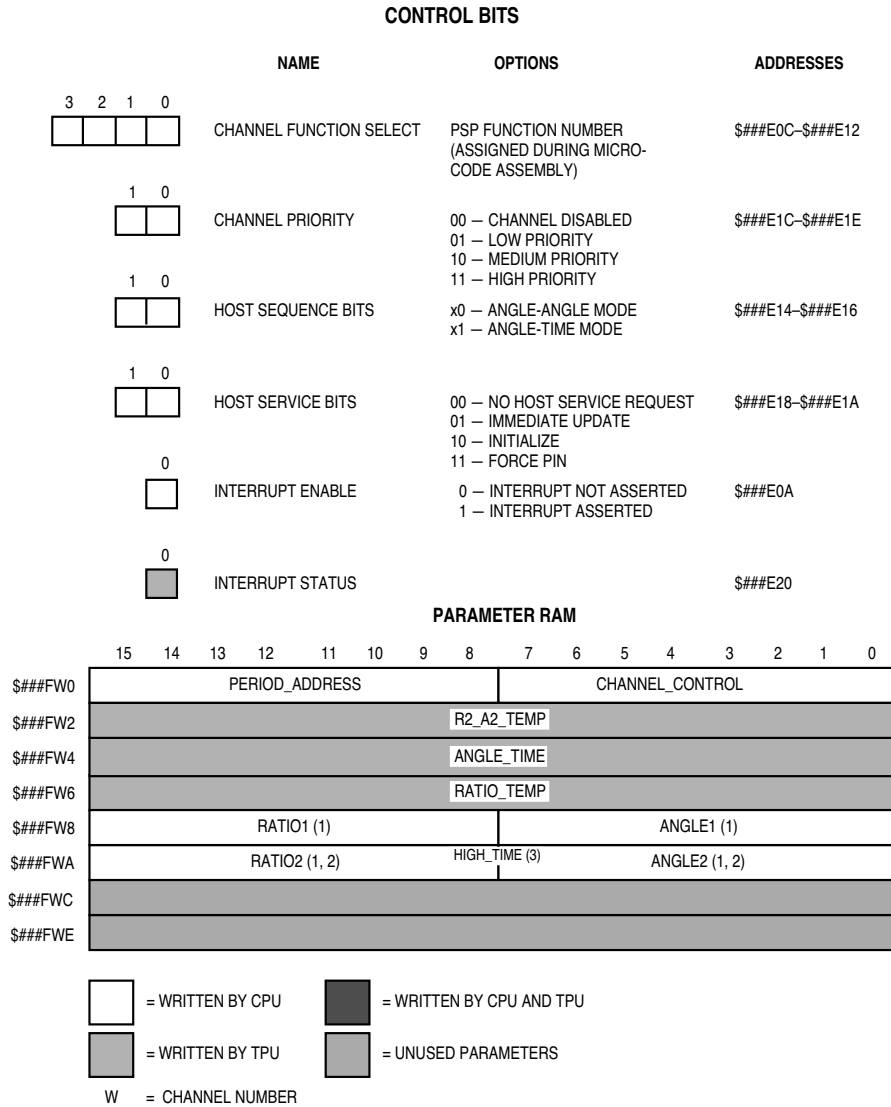

NOTES:

1. RESTRICTIONS ON THE ANGLE AND RATIO PARAMETERS:
 - A) ANGLE1 AND ANGLE2 MUST BE A VALUE THAT IS IN THE COUNTING RANGE OF TCR2 FOR THE APPLICATION.
 - B) IF ANGLE1 = ANGLE2, THEN RATIO2 MUST BE GREATER THAN RATIO1.
 - C) A RESTRICTION IS PLACED UPON THESE PARAMETERS BECAUSE OF TPU LATENCY; E.G., IF THE OUTPUT PULSE IS PROGRAMMED TO BE 99.9% DUTY CYCLE, AN OUTPUT PULSE OF A SMALLER PERCENTAGE MAY RESULT.
2. USED ONLY IN ANGLE-ANGLE MODE.
3. USED ONLY IN ANGLE-TIME MODE.

1043A

Figure A-5 PSP Parameters

A.8 Period Measurement with Additional Transition Detection (PMA)

The PMA function measures the period (in TCR1 clocks) between regularly occurring input transitions and makes this period available for use by other functions or by the CPU. The function detects when the period between transitions is less than a user-specified fraction of the last “normal” period, indicating the presence of additional transitions.

This function is used primarily in toothed-wheel speed-sensing applications, such as monitoring rotational speed of an engine. The period measurement with additional transition detect (PMA) function allows for a special-purpose 23-bit period measurement. It can detect the occurrence of an additional transition (caused by an extra tooth on the sensed wheel) indicated by a period measurement that is less than a programmable ratio of the previous period measurement. Once detected, this condition can be counted and compared to a programmable number of additional transitions detected before TCR2 is reset to \$FFFF. Alternately, a byte at an address specified by a channel parameter can be read and used as a flag. A non-zero value of the flag indicates that TCR2 is to be reset to \$FFFF once the next additional transition is detected.

Figure A-6 shows the host interface areas and parameter RAM for the PMA function.

CONTROL BITS

NAME	OPTIONS	ADDRESSES	
<div style="display: flex; justify-content: space-around; width: 100px;"> 3210 </div> <div style="display: flex; justify-content: space-around; width: 100px;"> <div style="border: 1px solid black; width: 20px; height: 20px;"></div> <div style="border: 1px solid black; width: 20px; height: 20px;"></div> <div style="border: 1px solid black; width: 20px; height: 20px;"></div> <div style="border: 1px solid black; width: 20px; height: 20px;"></div> </div>	CHANNEL FUNCTION SELECT	PMA FUNCTION NUMBER (ASSIGNED DURING MICRO-CODE ASSEMBLY)	###E0C-###E12
<div style="display: flex; justify-content: space-around; width: 100px;"> 10 </div> <div style="display: flex; justify-content: space-around; width: 100px;"> <div style="border: 1px solid black; width: 20px; height: 20px;"></div> <div style="border: 1px solid black; width: 20px; height: 20px;"></div> </div>	CHANNEL PRIORITY	00 – DISABLE 01 – LOW PRIORITY 10 – MEDIUM PRIORITY 11 – HIGH PRIORITY	###E1C-###E1E
<div style="display: flex; justify-content: space-around; width: 100px;"> 10 </div> <div style="display: flex; justify-content: space-around; width: 100px;"> <div style="border: 1px solid black; width: 20px; height: 20px;"></div> <div style="border: 1px solid black; width: 20px; height: 20px;"></div> </div>	HOST SEQUENCE BITS	00 – ADDITIONAL TOOTH BANK MODE 01 – ADDITIONAL TOOTH COUNT MODE 10 – (MISSING TOOTH BANK MODE) 11 – (MISSING TOOTH COUNT MODE)	###E14-###E16
<div style="display: flex; justify-content: space-around; width: 100px;"> 10 </div> <div style="display: flex; justify-content: space-around; width: 100px;"> <div style="border: 1px solid black; width: 20px; height: 20px;"></div> <div style="border: 1px solid black; width: 20px; height: 20px;"></div> </div>	HOST SERVICE BITS	00 – NO HOST SERVICE REQUEST 01 – INITIALIZE 10 – NOT USED 11 – NOT USED	###E18-###E1A
<div style="display: flex; justify-content: space-around; width: 100px;"> 0 </div> <div style="display: flex; justify-content: space-around; width: 100px;"> <div style="border: 1px solid black; width: 20px; height: 20px;"></div> </div>	INTERRUPT ENABLE	0 – INTERRUPT NOT ASSERTED 1 – INTERRUPT ASSERTED	###E0A
<div style="display: flex; justify-content: space-around; width: 100px;"> 0 </div> <div style="display: flex; justify-content: space-around; width: 100px;"> <div style="background-color: gray; width: 20px; height: 20px;"></div> </div>	INTERRUPT STATUS		###E20

PARAMETER RAM

	15	14	13	12	11	10	9	8	7	6	5	4	3	2	1	0
###FW0	REF_TIME								CHANNEL_CONTROL							
###FW2	MAX_ADDITIONAL								NUM_OF_TEETH							
###FW4	BANK_SIGNAL/ADDITIONAL_COUNT								ROLLOVER_COUNT							
###FW6	RATIO								TCR2_MAX_VALUE							
###FW8	PERIOD_HIGH_WORD															
###FWA	PERIOD_LOW_WORD															
###FFC	ERROR				TCR2_VALUE											

= WRITTEN BY CPU
 = WRITTEN BY CPU AND TPU
 = WRITTEN BY TPU
 = UNUSED PARAMETERS
 W = CHANNEL NUMBER

1034A

Figure A-6 PMA Parameters

A.9 Period Measurement with Missing Transition Detection (PMM)

Period measurement with missing transition detect (PMM) allows a special-purpose 23-bit period measurement. It detects the occurrence of a missing transition (caused by a missing tooth on the sensed wheel), indicated by a period measurement that is greater than a programmable ratio of the previous period measurement. Once detected, this condition can be counted and compared to a programmable number of additional transitions detected before TCR2 is reset to \$FFFF. In addition, one byte at an address specified by a channel parameter can be read and used as a flag. A non-zero value of the flag indicates that TCR2 is to be reset to \$FFFF once the next missing transition is detected.

Figure A-7 shows the host interface areas and parameter RAM for the PMM function.

CONTROL BITS

NAME	OPTIONS	ADDRESSES	
<div style="display: flex; justify-content: space-around; width: 100px;"> 3210 </div> <div style="display: flex; justify-content: space-around; width: 100px;"> <div style="border: 1px solid black; width: 20px; height: 20px;"></div> <div style="border: 1px solid black; width: 20px; height: 20px;"></div> <div style="border: 1px solid black; width: 20px; height: 20px;"></div> <div style="border: 1px solid black; width: 20px; height: 20px;"></div> </div>	CHANNEL FUNCTION SELECT	PMM FUNCTION NUMBER (ASSIGNED DURING MICRO-CODE ASSEMBLY)	###E0C-###E12
<div style="display: flex; justify-content: space-around; width: 50px;"> 10 </div> <div style="display: flex; justify-content: space-around; width: 50px;"> <div style="border: 1px solid black; width: 20px; height: 20px;"></div> <div style="border: 1px solid black; width: 20px; height: 20px;"></div> </div>	CHANNEL PRIORITY	00 – DISABLE 01 – LOW PRIORITY 10 – MEDIUM PRIORITY 11 – HIGH PRIORITY	###E1C-###E1E
<div style="display: flex; justify-content: space-around; width: 50px;"> 10 </div> <div style="display: flex; justify-content: space-around; width: 50px;"> <div style="border: 1px solid black; width: 20px; height: 20px;"></div> <div style="border: 1px solid black; width: 20px; height: 20px;"></div> </div>	HOST SEQUENCE BITS	00 – (ADDITIONAL TOOTH BANK MODE) 01 – (ADDITIONAL TOOTH COUNT MODE) 10 – MISSING TOOTH BANK MODE 11 – MISSING TOOTH COUNT MODE	###E14-###E16
<div style="display: flex; justify-content: space-around; width: 50px;"> 10 </div> <div style="display: flex; justify-content: space-around; width: 50px;"> <div style="border: 1px solid black; width: 20px; height: 20px;"></div> <div style="border: 1px solid black; width: 20px; height: 20px;"></div> </div>	HOST SERVICE BITS	00 – NO HOST SERVICE REQUEST 01 – INITIALIZE 10 – NOT USED 11 – NOT USED	###E18-###E1A
<div style="display: flex; justify-content: space-around; width: 50px;"> 0 </div> <div style="display: flex; justify-content: space-around; width: 50px;"> <div style="border: 1px solid black; width: 20px; height: 20px;"></div> </div>	INTERRUPT ENABLE	0 – INTERRUPT NOT ASSERTED 1 – INTERRUPT ASSERTED	###E0A
<div style="display: flex; justify-content: space-around; width: 50px;"> 0 </div> <div style="display: flex; justify-content: space-around; width: 50px;"> <div style="background-color: #cccccc; width: 20px; height: 20px;"></div> </div>	INTERRUPT STATUS		###E20

PARAMETER RAM

	15	14	13	12	11	10	9	8	7	6	5	4	3	2	1	0
###FW0	REF_TIME								CHANNEL_CONTROL							
###FW2	MAX_MISSING								NUM_OF_TEETH							
###FW4	BANK_SIGNAL/MISSING_COUNT								ROLLOVER_COUNT							
###FW6	RATIO								TCR2_MAX_VALUE							
###FW8	PERIOD_HIGH_WORD															
###FWA	PERIOD_LOW_WORD															
###FFC	ERROR								TCR2_VALUE							

<div style="display: flex; justify-content: space-around;"> <div style="border: 1px solid black; width: 20px; height: 20px; background-color: white;"></div> = WRITTEN BY CPU <div style="border: 1px solid black; width: 20px; height: 20px; background-color: #cccccc;"></div> = WRITTEN BY TPU W = CHANNEL NUMBER </div>	<div style="display: flex; justify-content: space-around;"> <div style="background-color: #333333; width: 20px; height: 20px;"></div> = WRITTEN BY CPU AND TPU <div style="background-color: #999999; width: 20px; height: 20px;"></div> = UNUSED PARAMETERS </div>
---	--

1038A

Figure A-7 PMM Parameters

A.10 Input Capture/Input Transition Counter (ITC)

Any channel of the TPU can capture the value of a specified TCR upon the occurrence of each transition or specified number of transitions, and then generate an interrupt request to notify the CPU. A channel can perform input captures continually, or a channel can detect a single transition or specified number of transitions, then cease channel activity until reinitialization. After each transition or specified number of transitions, the channel can generate a link to a sequential block of up to eight channels. The user specifies a starting channel of the block and the number of channels within the block. The generation of links depends on the mode of operation. In addition, after each transition or specified number of transitions, one byte of the parameter RAM (at an address specified by channel parameter) can be incremented and used as a flag to notify another channel of a transition.

Figure A-8 shows the host interface areas and parameter RAM for the ITC function.

CONTROL BITS

	NAME	OPTIONS	ADDRESSES
3 2 1 0 <input type="checkbox"/> <input type="checkbox"/> <input type="checkbox"/> <input type="checkbox"/>	CHANNEL FUNCTION SELECT	ITC FUNCTION NUMBER (ASSIGNED DURING MICRO-CODE ASSEMBLY)	###E0C-###E12
1 0 <input type="checkbox"/> <input type="checkbox"/>	CHANNEL PRIORITY	00 – DISABLE 01 – LOW PRIORITY 10 – MEDIUM PRIORITY 11 – HIGH PRIORITY	###E1C-###E1E
1 0 <input type="checkbox"/> <input type="checkbox"/>	HOST SEQUENCE BITS	00 – SINGLE-SHOT MODE, NO LINKS 01 – CONTINUOUS MODE, NO LINKS 10 – SINGLE-SHOT MODE, LINKS 11 – CONTINUOUS MODE, LINKS	###E14-###E16
1 0 <input type="checkbox"/> <input type="checkbox"/>	HOST SERVICE BITS	00 – NOT USED 01 – INITIALIZE 10 – NOT USED 11 – NOT USED	###E18-###E1A
0 <input type="checkbox"/>	INTERRUPT ENABLE	0 – INTERRUPT NOT ASSERTED 1 – INTERRUPT ASSERTED	###E0A
0 <input type="checkbox"/>	INTERRUPT STATUS		###E20

PARAMETER RAM

	15	14	13	12	11	10	9	8	7	6	5	4	3	2	1	0
###FW0									CHANNEL_CONTROL							
###FW2	START_LINK_CHANNEL				LINK_CHANNEL_COUNT (2)				BANK_ADDRESS				0			
###FW4	MAX_COUNT (1, 3)															
###FW6	TRANS_COUNT (1)															
###FW8	FINAL_TRANS_TIME															
###FWA	LAST_TRANS_TIME															
###FWC																
###FWE																

<input type="checkbox"/> = WRITTEN BY CPU	<input checked="" type="checkbox"/> = WRITTEN BY CPU AND TPU
<input checked="" type="checkbox"/> = WRITTEN BY TPU	<input type="checkbox"/> = UNUSED PARAMETERS

W = CHANNEL NUMBER

NOTES:

1. MAX_COUNT AND TRANS_COUNT SHOULD BE ACCESSED COHERENTLY AND RESIDE ON A DOUBLE-WORD BOUNDARY.
2. THE TPU DOES NOT PERFORM CHECKS ON LINK_CHANNEL_COUNT VALUE. IF LINK_CHANNEL_COUNT IS GREATER THAN EIGHT OR EQUAL TO ZERO, RESULTS ARE UNPREDICTABLE.
3. MAX_COUNT SHOULD BE BETWEEN ZERO AND \$FFFF. IF MAX_COUNT EQUALS ZERO, THE TPU COUNTS ONE TRANSITION.

1019A

Figure A-8 ITC Parameters

A.11 Pulse-Width Modulation (PWM)

The TPU can generate a pulse-width modulation (PWM) waveform with any duty cycle from zero to 100% (within the resolution and latency capability of the TPU). To define the PWM, the CPU provides one parameter that indicates the period and another parameter that indicates the high time. Updates to one or both of these parameters can direct the waveform change to take effect immediately, or coherently beginning at the next low-to-high transition of the pin.

Figure A-9 shows the host interface areas and parameter RAM for the PWM function.

CONTROL BITS

	NAME	OPTIONS	ADDRESSES
<div style="display: flex; justify-content: space-around; width: 100px;"> 3210 </div> <div style="display: flex; justify-content: space-around; width: 100px;"> <div style="border: 1px solid black; width: 20px; height: 20px;"></div> <div style="border: 1px solid black; width: 20px; height: 20px;"></div> <div style="border: 1px solid black; width: 20px; height: 20px;"></div> <div style="border: 1px solid black; width: 20px; height: 20px;"></div> </div>	CHANNEL FUNCTION SELECT	PWM FUNCTION NUMBER (ASSIGNED DURING MICRO-CODE ASSEMBLY)	\$###E0C-\$###E12
<div style="display: flex; justify-content: space-around; width: 100px;"> 10 </div> <div style="display: flex; justify-content: space-around; width: 100px;"> <div style="border: 1px solid black; width: 20px; height: 20px;"></div> <div style="border: 1px solid black; width: 20px; height: 20px;"></div> </div>	CHANNEL PRIORITY	00 – DISABLE 01 – LOW PRIORITY 10 – MEDIUM PRIORITY 11 – HIGH PRIORITY	\$###E1C-\$###E1E
<div style="display: flex; justify-content: space-around; width: 100px;"> 10 </div> <div style="display: flex; justify-content: space-around; width: 100px;"> <div style="border: 1px solid black; width: 20px; height: 20px;"></div> <div style="border: 1px solid black; width: 20px; height: 20px;"></div> </div>	HOST SEQUENCE BITS	xx – NOT USED	\$###E14-\$###E16
<div style="display: flex; justify-content: space-around; width: 100px;"> 10 </div> <div style="display: flex; justify-content: space-around; width: 100px;"> <div style="border: 1px solid black; width: 20px; height: 20px;"></div> <div style="border: 1px solid black; width: 20px; height: 20px;"></div> </div>	HOST SERVICE BITS	00 – NOT USED 01 – IMMEDIATE UPDATE OF PWM 10 – INITIALIZE 11 – NOT USED	\$###E18-\$###E1A
<div style="display: flex; justify-content: space-around; width: 100px;"> 0 </div> <div style="display: flex; justify-content: space-around; width: 100px;"> <div style="border: 1px solid black; width: 20px; height: 20px;"></div> </div>	INTERRUPT ENABLE	0 – INTERRUPT NOT ASSERTED 1 – INTERRUPT ASSERTED	\$###E0A
<div style="display: flex; justify-content: space-around; width: 100px;"> 0 </div> <div style="display: flex; justify-content: space-around; width: 100px;"> <div style="background-color: gray; width: 20px; height: 20px;"></div> </div>	INTERRUPT STATUS		\$###E20

PARAMETER RAM

	15	14	13	12	11	10	9	8	7	6	5	4	3	2	1	0
\$###FW0									CHANNEL_CONTROL							
\$###FW2									OLDRIS							
\$###FW4									PWMHI (1, 3)							
\$###FW6									PWMPER (2,3)							
\$###FW8									PWMRIS							
\$###FWA																
\$###FWC																
\$###FWE																

<div style="display: flex; justify-content: space-around;"> <div style="border: 1px solid black; width: 20px; height: 20px; background-color: white;"></div> = WRITTEN BY CPU </div>	<div style="display: flex; justify-content: space-around;"> <div style="background-color: gray; width: 20px; height: 20px;"></div> = WRITTEN BY CPU AND TPU </div>
<div style="display: flex; justify-content: space-around;"> <div style="background-color: gray; width: 20px; height: 20px;"></div> = WRITTEN BY TPU </div>	<div style="display: flex; justify-content: space-around;"> <div style="background-color: lightgray; width: 20px; height: 20px;"></div> = UNUSED PARAMETERS </div>
W = CHANNEL NUMBER	

NOTES:

1. BEST-CASE MINIMUM FOR PWMHI IS 32 SYSTEM CLOCK CYCLES.
2. BEST-CASE MINIMUM FOR PWMPER IS 48 SYSTEM CLOCK CYCLES.
3. PWMHI AND PWMPER MUST BE ACCESSED COHERENTLY.

1027A

Figure A-9 PWM Parameters

A.12 Discrete Input/Output (DIO)

The DIO function allows a TPU channel to be used as a digital I/O pin.

When a pin is used as a discrete input, a parameter indicates the current input level and the previous 15 levels of a pin. Bit 15, the most significant bit of the parameter, indicates the most recent state. Bit 14 indicates the next most recent state, and so on. The programmer can choose one of the three following conditions to update the parameter: 1) when a transition occurs, 2) when the CPU makes a request, or 3) when a rate specified in another parameter is matched.

When a pin is used as a discrete output, it is set high or low only upon request by the CPU.

Figure A-10 shows the host interface areas for the DIO function.

CONTROL BITS

	NAME	OPTIONS	ADDRESSES
<div style="display: flex; justify-content: space-around; width: 100px;"> 3210 </div> <div style="display: flex; justify-content: space-around; width: 100px;"> <div style="border: 1px solid black; width: 20px; height: 20px;"></div> <div style="border: 1px solid black; width: 20px; height: 20px;"></div> <div style="border: 1px solid black; width: 20px; height: 20px;"></div> <div style="border: 1px solid black; width: 20px; height: 20px;"></div> </div>	CHANNEL FUNCTION SELECT	DIO FUNCTION NUMBER (ASSIGNED DURING MICRO-CODE ASSEMBLY)	\$\$\$E0C-\$\$\$E12
<div style="display: flex; justify-content: space-around; width: 50px;"> 10 </div> <div style="display: flex; justify-content: space-around; width: 50px;"> <div style="border: 1px solid black; width: 20px; height: 20px;"></div> <div style="border: 1px solid black; width: 20px; height: 20px;"></div> </div>	CHANNEL PRIORITY	00 – DISABLE 01 – LOW PRIORITY 10 – MEDIUM PRIORITY 11 – HIGH PRIORITY	\$\$\$E1C-\$\$\$E1E
<div style="display: flex; justify-content: space-around; width: 50px;"> 10 </div> <div style="display: flex; justify-content: space-around; width: 50px;"> <div style="border: 1px solid black; width: 20px; height: 20px;"></div> <div style="border: 1px solid black; width: 20px; height: 20px;"></div> </div>	HOST SEQUENCE BITS	00 – UPDATE ON TRANSITION 01 – UPDATE AT MATCH RATE 10 – UPDATE ON HSR 11 11 – NOT USED	\$\$\$E14-\$\$\$E16
<div style="display: flex; justify-content: space-around; width: 50px;"> 10 </div> <div style="display: flex; justify-content: space-around; width: 50px;"> <div style="border: 1px solid black; width: 20px; height: 20px;"></div> <div style="border: 1px solid black; width: 20px; height: 20px;"></div> </div>	HOST SERVICE BITS	00 – NOT USED 01 – DRIVE PIN HIGH 10 – DRIVE PIN LOW 11 – INITIALIZE	\$\$\$E18-\$\$\$E1A
<div style="display: flex; justify-content: space-around; width: 50px;"> 0 </div> <div style="display: flex; justify-content: space-around; width: 50px;"> <div style="border: 1px solid black; width: 20px; height: 20px;"></div> </div>	INTERRUPT ENABLE	0 – INTERRUPT NOT ASSERTED 1 – INTERRUPT ASSERTED	\$\$\$E0A
<div style="display: flex; justify-content: space-around; width: 50px;"> 0 </div> <div style="display: flex; justify-content: space-around; width: 50px;"> <div style="background-color: #cccccc; width: 20px; height: 20px;"></div> </div>	INTERRUPT STATUS		\$\$\$E20

PARAMETER RAM

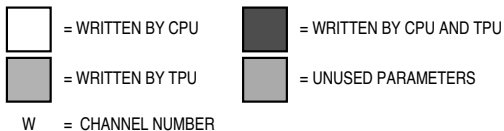
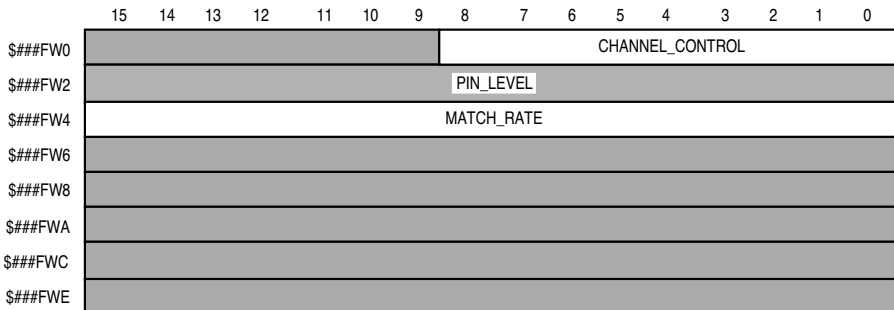

1017A

Figure A-10 DIO Parameters

A.13 Synchronized Pulse-Width Modulation (SPWM)

The SPWM function generates a pulse-width modulated waveform (PWM). The CPU can change the period or high time of the waveform at any time. Three different operating modes allow the function to maintain complex timing relationships between channels without CPU intervention.

The SPWM output waveform duty cycle excludes 0% and 100%. If a PWM does not need to maintain a time relationship to another PWM, the PWM function should be used instead.

Figures A-11 and A-12 show all of the host interface areas for the SPWM function.

CONTROL BITS

NAME	OPTIONS	ADDRESSES	
<div style="display: flex; justify-content: space-around; width: 100px;"> 3210 </div> <div style="display: flex; justify-content: space-around; width: 100px;"> <div style="border: 1px solid black; width: 20px; height: 20px;"></div> <div style="border: 1px solid black; width: 20px; height: 20px;"></div> <div style="border: 1px solid black; width: 20px; height: 20px;"></div> <div style="border: 1px solid black; width: 20px; height: 20px;"></div> </div>	CHANNEL FUNCTION SELECT	SPWM FUNCTION NUMBER (ASSIGNED DURING MICRO-CODE ASSEMBLY)	###E0C-###E12
<div style="display: flex; justify-content: space-around; width: 100px;"> 10 </div> <div style="display: flex; justify-content: space-around; width: 100px;"> <div style="border: 1px solid black; width: 20px; height: 20px;"></div> <div style="border: 1px solid black; width: 20px; height: 20px;"></div> </div>	CHANNEL PRIORITY	00 – DISABLE 01 – LOW PRIORITY 10 – MEDIUM PRIORITY 11 – HIGH PRIORITY	###E1C-###E1E
<div style="display: flex; justify-content: space-around; width: 100px;"> 10 </div> <div style="display: flex; justify-content: space-around; width: 100px;"> <div style="border: 1px solid black; width: 20px; height: 20px;"></div> <div style="border: 1px solid black; width: 20px; height: 20px;"></div> </div>	HOST SEQUENCE BITS	00 – MODE 0 01 – MODE 1 10 – MODE 2 11 – NOT USED	###E14-###E16
<div style="display: flex; justify-content: space-around; width: 100px;"> 10 </div> <div style="display: flex; justify-content: space-around; width: 100px;"> <div style="border: 1px solid black; width: 20px; height: 20px;"></div> <div style="border: 1px solid black; width: 20px; height: 20px;"></div> </div>	HOST SERVICE BITS	00 – NO HOST SERVICE REQUEST 01 – NOT USED 10 – INITIALIZE 11 – IMMEDIATE UPDATE (MODE 1)	###E18-###E1A
<div style="display: flex; justify-content: space-around; width: 100px;"> 0 </div> <div style="display: flex; justify-content: space-around; width: 100px;"> <div style="border: 1px solid black; width: 20px; height: 20px;"></div> </div>	INTERRUPT ENABLE	0 – INTERRUPT NOT ASSERTED 1 – INTERRUPT ASSERTED	###E0A
<div style="display: flex; justify-content: space-around; width: 100px;"> 0 </div> <div style="display: flex; justify-content: space-around; width: 100px;"> <div style="background-color: #cccccc; width: 20px; height: 20px;"></div> </div>	INTERRUPT STATUS		###E20

PARAMETER RAM (MODE 0)

	15	14	13	12	11	10	9	8	7	6	5	4	3	2	1	0
###FW0	LASTRISE							CHANNEL_CONTROL								
###FW2	NEXTRISE															
###FW4	HIGH_TIME															
###FW6	PERIOD															
###FW8									REF_ADDR1							
###FWA	DELAY															
###FWC																
###FWE																

<div style="display: flex; justify-content: space-around;"> <div style="border: 1px solid black; width: 20px; height: 20px; background-color: white;"></div> <div style="border: 1px solid black; width: 20px; height: 20px; background-color: #cccccc;"></div> </div> <p style="text-align: center;">= WRITTEN BY CPU</p>	<div style="display: flex; justify-content: space-around;"> <div style="background-color: #cccccc; width: 20px; height: 20px;"></div> <div style="background-color: #999999; width: 20px; height: 20px;"></div> </div> <p style="text-align: center;">= WRITTEN BY CPU AND TPU</p> <p style="text-align: center;">= WRITTEN BY TPU</p> <p style="text-align: center;">= UNUSED PARAMETERS</p>
<p>W = CHANNEL NUMBER</p>	

1030A-1

Figure A-11 SPWM Parameters, Part 1 of 2

PARAMETER RAM (MODE 1)

	15	14	13	12	11	10	9	8	7	6	5	4	3	2	1	0
###FW0	LASTRISE							CHANNEL_CONTROL								
###FW2	NEXTRISE															
###FW4	HIGH_TIME															
###FW6	DELAY															
###FW8	REF_ADDR1							REF_ADDR2								
###FWA	REF_VALUE															
###FWC																
###FWE																

PARAMETER RAM (MODE 2)

	15	14	13	12	11	10	9	8	7	6	5	4	3	2	1	0
###FW0	LASTRISE							CHANNEL_CONTROL								
###FW2	NEXTRISE															
###FW4	HIGH_TIME															
###FW6	PERIOD															
###FW8	START_LINK_CHANNEL				LINK_CHANNEL_COUNT				REF_ADDR1							
###FWA	DELAY															
###FWC																
###FWE																

- = WRITTEN BY CPU
- = WRITTEN BY CPU AND TPU
- = WRITTEN BY TPU
- = UNUSED PARAMETERS
- W = CHANNEL NUMBER

1030A-2

Figure A-12 SPWM Parameters, Part 2 of 2

A.14 Quadrature Decode (QDEC)

QDEC uses two channels to decode a pair of out-of-phase signals in order to present the CPU with directional information and a position value. It is particularly suitable for use with slotted encoders employed in motor control. The function derives full resolution from the encoder signals and provides a 16-bit position counter with rollover/under indication via an interrupt.

Figure A-13 shows all of the host interface areas for the QDEC function.

CONTROL BITS

	NAME	OPTIONS	ADDRESSES
<div style="display: flex; justify-content: space-around; width: 100px;"> 3210 </div> <div style="display: flex; justify-content: space-around; width: 100px;"> <div style="border: 1px solid black; width: 20px; height: 20px;"></div> <div style="border: 1px solid black; width: 20px; height: 20px;"></div> <div style="border: 1px solid black; width: 20px; height: 20px;"></div> <div style="border: 1px solid black; width: 20px; height: 20px;"></div> </div>	CHANNEL FUNCTION SELECT	QDEC FUNCTION NUMBER (ASSIGNED DURING MICRO-CODE ASSEMBLY)	\$\$\$E0C-\$\$\$E12
<div style="display: flex; justify-content: space-around; width: 100px;"> 10 </div> <div style="display: flex; justify-content: space-around; width: 100px;"> <div style="border: 1px solid black; width: 20px; height: 20px;"></div> <div style="border: 1px solid black; width: 20px; height: 20px;"></div> </div>	CHANNEL PRIORITY	00 – DISABLE 01 – LOW PRIORITY 10 – MIDDLE PRIORITY 11 – HIGH PRIORITY	\$\$\$E1C-\$\$\$E1E
<div style="display: flex; justify-content: space-around; width: 100px;"> 10 </div> <div style="display: flex; justify-content: space-around; width: 100px;"> <div style="border: 1px solid black; width: 20px; height: 20px;"></div> <div style="border: 1px solid black; width: 20px; height: 20px;"></div> </div>	HOST SEQUENCE BITS	x0 – PRIMARY CHANNEL x1 – SECONDARY CHANNEL	\$\$\$E14-\$\$\$E16
<div style="display: flex; justify-content: space-around; width: 100px;"> 10 </div> <div style="display: flex; justify-content: space-around; width: 100px;"> <div style="border: 1px solid black; width: 20px; height: 20px;"></div> <div style="border: 1px solid black; width: 20px; height: 20px;"></div> </div>	HOST SERVICE BITS	0x – NO ACTION 10 – READ TCR1 11 – INITIALIZE	\$\$\$E18-\$\$\$E1A
<div style="display: flex; justify-content: space-around; width: 100px;"> 0 </div> <div style="display: flex; justify-content: space-around; width: 100px;"> <div style="border: 1px solid black; width: 20px; height: 20px;"></div> </div>	INTERRUPT ENABLE	x – NO INTERRUPT	\$\$\$E0A
<div style="display: flex; justify-content: space-around; width: 100px;"> 0 </div> <div style="display: flex; justify-content: space-around; width: 100px;"> <div style="background-color: #cccccc; width: 20px; height: 20px;"></div> </div>	INTERRUPT STATUS	INTERRUPTS NOT USED	\$\$\$E20

PARAMETER RAM

	15	14	13	12	11	10	9	8	7	6	5	4	3	2	1	0
\$\$\$FW0	EDGE_TIME*															
\$\$\$FW2	POSITION_COUNT*															
\$\$\$FW4	TCR1_VALUE															
\$\$\$FW6	CHAN_PINSTATE															
\$\$\$FW8	CORR_PINSTATE_ADDR															
\$\$\$FWA	EDGE_TIME_LSB_ADDR															
\$\$\$FWC																
\$\$\$FWE																

	= WRITTEN BY CPU		= WRITTEN BY CPU AND TPU
	= WRITTEN BY TPU		= UNUSED PARAMETERS

W = CHANNEL NUMBER

* THE PARAMETERS EDGE_TIME AND POSITION_COUNT EXIST IN ONLY ONE OF THE QDEC CHANNELS. EDGE_TIME_LSB_ADDR MUST HAVE THE SAME VALUE IN BOTH CHANNELS.

TPU QDEC CHRT

Figure A-13 QDEC Parameters

A.15 Programmable Time Accumulator (PTA)

PTA accumulates a 32-bit sum of the total high time, low time, or period of an input signal over a programmable number of periods or pulses. The period accumulation can start on a rising or falling edge. After the specified number of periods or pulses, the PTA generates an interrupt request.

From 1 to 255 period measurements can be accumulated before the TPU interrupts the CPU, providing instantaneous or average frequency measurement capability.

Figure A-14 shows all of the host interface areas for the PTA function.

CONTROL BITS

	NAME	OPTIONS	ADDRESSES
3 2 1 0 <input type="checkbox"/> <input type="checkbox"/> <input type="checkbox"/> <input type="checkbox"/>	CHANNEL FUNCTION SELECT	PTA FUNCTION NUMBER (ASSIGNED DURING MICRO-CODE ASSEMBLY)	###E0C-###E12
1 0 <input type="checkbox"/> <input type="checkbox"/>	HOST SEQUENCE	00 – HIGH TIME ACCUMULATE 01 – LOW TIME ACCUMULATE 10 – PERIOD ACCUMULATE, RISING 11 – PERIOD ACCUMULATE, FALLING	###E14-###E16
1 0 <input type="checkbox"/> <input type="checkbox"/>	HOST SERVICE REQUEST	00 – NO HOST SERVICE (RESET CONDITION) 01 – NOT USED 10 – NOT USED 11 – INITIALIZE	###E18-###E1A
1 0 <input type="checkbox"/> <input type="checkbox"/>	CHANNEL PRIORITY	00 – DISABLED 01 – LOW PRIORITY 10 – MEDIUM PRIORITY 11 – HIGH PRIORITY	###E1C-###E1E
0 <input type="checkbox"/>	CHANNEL INTERRUPT ENABLE	0 – CHANNEL INTERRUPTS DISABLED 1 – CHANNEL INTERRUPTS ENABLED	###E0A
0 <input type="checkbox"/>	CHANNEL INTERRUPT STATUS	0 – CHANNEL INTERRUPT NOT ASSERTED 1 – CHANNEL INTERRUPT ASSERTED	###E20

PARAMETER RAM

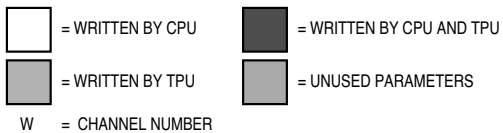
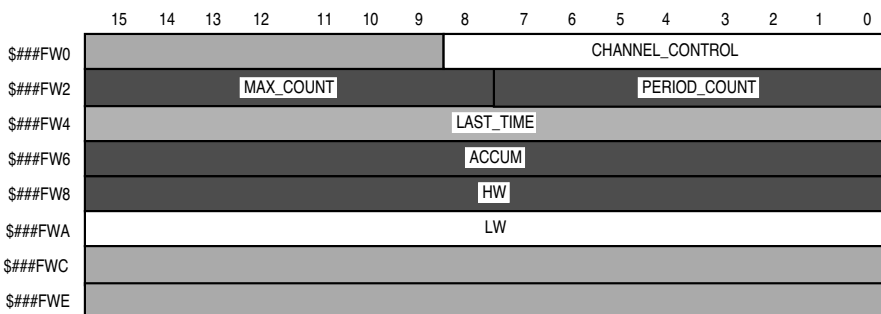

TPU PTA CHRT

Figure A-14 PTA Parameters

A.16 Queued Output Match TPU Function (QOM)

QOM can generate single or multiple output match events from a table of offsets in parameter RAM. Loop modes allow complex pulse trains to be generated once, a specified number of times, or continuously. The function can be triggered by a link from another TPU channel. In addition, the reference time for the sequence of matches can be obtained from another channel. QOM can generate pulse-width modulated waveforms, including waveforms with high times of 0% or 100%. QOM also allows a TPU channel to be used as a discrete output pin.

Figure A-15 shows all of the host interface areas for the QOM function. The bit encodings shown in **Table A-4** describe the corresponding fields in parameter RAM.

Table A-4 QOM Bit Encoding

A	Timebase Selection
0	Use TCR1 as Timebase
1	Use TCR2 as Timebase

	Edge Selection
↓	Falling Edge at Match
↑	Rising Edge at Match

B:C	Reference for First Match
00	Immediate TCR Value
01	Last Event Time
10	Value Pointed to by REF_ADDR
11	Last Event Time

CONTROL BITS

3 2 1 0	NAME	OPTIONS	ADDRESSES				
<table border="1" style="display: inline-table; width: 40px; height: 20px;"> <tr><td style="width: 10px; height: 10px;"></td><td style="width: 10px; height: 10px;"></td><td style="width: 10px; height: 10px;"></td><td style="width: 10px; height: 10px;"></td></tr> </table>					CHANNEL FUNCTION SELECT	QOM FUNCTION NUMBER (ASSIGNED DURING MICRO-CODE ASSEMBLY)	\$###E0C-\$###E12
<table border="1" style="display: inline-table; width: 40px; height: 20px;"> <tr><td style="width: 10px; height: 10px;"></td><td style="width: 10px; height: 10px;"></td></tr> </table>			HOST SEQUENCE	00 – SINGLE-SHOT MODE 01 – LOOP MODE 10 – CONTINUOUS MODE 11 – CONTINUOUS MODE	\$###E14-\$###E16		
<table border="1" style="display: inline-table; width: 40px; height: 20px;"> <tr><td style="width: 10px; height: 10px;"></td><td style="width: 10px; height: 10px;"></td></tr> </table>			HOST SERVICE REQUEST	00 – NO HOST SERVICE (RESET CONDITION) 01 – INITIALIZE, NO PIN CHANGE 10 – INITIALIZE, PIN LOW 11 – INITIALIZE, PIN HIGH	\$###E18-\$###E1A		
<table border="1" style="display: inline-table; width: 40px; height: 20px;"> <tr><td style="width: 10px; height: 10px;"></td><td style="width: 10px; height: 10px;"></td></tr> </table>			CHANNEL PRIORITY	00 – DISABLED 01 – LOW PRIORITY 10 – MEDIUM PRIORITY 11 – HIGH PRIORITY	\$###E1C-\$###E1E		
<table border="1" style="display: inline-table; width: 40px; height: 20px;"> <tr><td style="width: 10px; height: 10px;"></td></tr> </table>		CHANNEL INTERRUPT ENABLE	0 – CHANNEL INTERRUPTS DISABLED 1 – CHANNEL INTERRUPTS ENABLED	\$###E0A			
<table border="1" style="display: inline-table; width: 40px; height: 20px;"> <tr><td style="width: 10px; height: 10px;"></td></tr> </table>		CHANNEL INTERRUPT STATUS	0 – CHANNEL INTERRUPT NOT ASSERTED 1 – CHANNEL INTERRUPT ASSERTED	\$###E20			

PARAMETER RAM

	15	14	13	12	11	10	9	8	7	6	5	4	3	2	1	0
\$###FW0	REF_ADDR						B	LAST_OFF_ADDR						A		
\$###FW2	LOOP_CNT						(LAST_MATCH_TIM)			OFF_PTR			C			
\$###FW4							OFFSET_1						↕			
\$###FW6							OFFSET_2						↕			
\$###FW8							OFFSET_3						↕			
\$###FWA							OFFSET_4						↕			
\$###FWC							OFFSET_5*						↕			
\$###FWE							OFFSET_6*						↕			
\$###F(W + 1)0							OFFSET_7*						↕			
\$###F(W + 1)2							OFFSET_8*						↕			
⋮							⋮						⋮			
\$###F(W + 1)14							OFFSET_14*						↕			

* NOT AVAILABLE ON ALL CHANNELS

<input style="width: 30px; height: 20px;" type="checkbox"/>	= WRITTEN BY CPU	<input style="width: 30px; height: 20px; background-color: #cccccc;" type="checkbox"/>	= WRITTEN BY CPU AND TPU
<input style="width: 30px; height: 20px; background-color: #cccccc;" type="checkbox"/>	= WRITTEN BY TPU	<input style="width: 30px; height: 20px;" type="checkbox"/>	= UNUSED PARAMETERS
W = PRIMARY CHANNEL NUMBER			

TPU QOM CHRT

Figure A-15 QOM Parameters

A.17 Table Stepper Motor (TSM)

The TSM function provides for acceleration and deceleration control of a stepper motor with a programmable number of step rates up to 58. TSM uses a table in parameter RAM, rather than an algorithm, to define the stepper motor acceleration profile, allowing the user to fully define the profile. In addition, a slew rate parameter allows fine control of the terminal running speed of the motor independent of the acceleration table. The CPU need only write a desired position, and the TPU accelerates, slews, and decelerates the motor to the required position. Full and half step support is provided for two-phase motors. In addition, a slew rate parameter allows fine control of the terminal running speed of the motor independent of the acceleration table.

Figures A-16 and **A-17** show all of the host interface areas for the TSM function when operating in master and slave mode, respectively.

CONTROL BITS

	NAME	OPTIONS	ADDRESSES
<div style="display: flex; justify-content: space-around; width: 40px;"> 3210 </div> <div style="border: 1px solid black; width: 40px; height: 15px; margin-top: 5px;"></div>	CHANNEL FUNCTION SELECT	TSM FUNCTION NUMBER (ASSIGNED DURING MICRO-CODE ASSEMBLY)	###E0C-###E12
<div style="display: flex; justify-content: space-around; width: 40px;"> 10 </div> <div style="border: 1px solid black; width: 40px; height: 15px; margin-top: 5px;"></div>	HOST SEQUENCE BITS	x0 – LOCAL MODE ACCELERATION TABLE x1 – SPLIT MODE ACCELERATION TABLE 0x – ROTATE PIN_SEQUENCE ONCE BETWEEN STEPS 1x – ROTATE PIN_SEQUENCE TWICE BETWEEN STEP	###E14-###E16
<div style="display: flex; justify-content: space-around; width: 40px;"> 10 </div> <div style="border: 1px solid black; width: 40px; height: 15px; margin-top: 5px;"></div>	HOST SERVICE BITS	00 – NO HOST SERVICE (RESET CONDITION) 01 – INITIALIZE, PIN LOW 10 – INITIALIZE, PIN HIGH 11 – MOVE REQUEST (MASTER ONLY)	###E18-###E1A
<div style="display: flex; justify-content: space-around; width: 40px;"> 10 </div> <div style="border: 1px solid black; width: 40px; height: 15px; margin-top: 5px;"></div>	CHANNEL PRIORITY	00 – DISABLED 01 – LOW PRIORITY 10 – MEDIUM PRIORITY 11 – HIGH PRIORITY	###E1C-###E1E
<div style="display: flex; justify-content: space-around; width: 40px;"> 0 </div> <div style="border: 1px solid black; width: 40px; height: 15px; margin-top: 5px;"></div>	CHANNEL INTERRUPT ENABLE	0 – CHANNEL INTERRUPTS DISABLED 1 – CHANNEL INTERRUPTS ENABLED	###E0A
<div style="display: flex; justify-content: space-around; width: 40px;"> 0 </div> <div style="background-color: #cccccc; width: 40px; height: 15px; margin-top: 5px;"></div>	CHANNEL INTERRUPT STATUS	0 – CHANNEL INTERRUPT NOT ASSERTED 1 – CHANNEL INTERRUPT ASSERTED	###E20

PARAMETER RAM

	15	14	13	12	11	10	9	8	7	6	5	4	3	2	1	0
###FW0	DESIRED_POSITION															
###FW2	CURRENT_POSITION															
###FW4	TABLE_SIZE								TABLE_INDEX							
###FW6	SLEW_PERIOD															S
###FW8	START_PERIOD															A
###FWA	PIN_SEQUENCE															
###FWC																
###FWE																

	= WRITTEN BY CPU		= WRITTEN BY CPU AND TPU
	= WRITTEN BY TPU		= UNUSED PARAMETERS
W	= PRIMARY CHANNEL NUMBER		

TPU TSM MAS CHRT

Figure A-16 TSM Parameters — Master Mode

CONTROL BITS

	NAME	OPTIONS	ADDRESSES
<div style="display: flex; justify-content: space-around; width: 100px;"> 3210 </div> <div style="display: flex; justify-content: space-around; width: 100px;"> <div style="border: 1px solid black; width: 20px; height: 20px;"></div> <div style="border: 1px solid black; width: 20px; height: 20px;"></div> <div style="border: 1px solid black; width: 20px; height: 20px;"></div> <div style="border: 1px solid black; width: 20px; height: 20px;"></div> </div>	CHANNEL FUNCTION SELECT	TSM FUNCTION NUMBER (ASSIGNED DURING MICRO-CODE ASSEMBLY)	####E0C-####E12
<div style="display: flex; justify-content: space-around; width: 100px;"> 10 </div> <div style="display: flex; justify-content: space-around; width: 100px;"> <div style="border: 1px solid black; width: 20px; height: 20px;"></div> <div style="border: 1px solid black; width: 20px; height: 20px;"></div> </div>	HOST SEQUENCE BITS	x0 – LOCAL MODE ACCELERATION TABLE x1 – SPLIT MODE ACCELERATION TABLE 0x – ROTATE PIN_SEQUENCE ONCE BETWEEN STEPS 1x – ROTATE PIN_SEQUENCE TWICE BETWEEN STEP	####E14-####E16
<div style="display: flex; justify-content: space-around; width: 100px;"> 10 </div> <div style="display: flex; justify-content: space-around; width: 100px;"> <div style="border: 1px solid black; width: 20px; height: 20px;"></div> <div style="border: 1px solid black; width: 20px; height: 20px;"></div> </div>	HOST SERVICE BITS	00 – NO HOST SERVICE (RESET CONDITION) 01 – INITIALIZE, PIN LOW 10 – INITIALIZE, PIN HIGH 11 – MOVE REQUEST (MASTER ONLY)	####E18-####E1A
<div style="display: flex; justify-content: space-around; width: 100px;"> 10 </div> <div style="display: flex; justify-content: space-around; width: 100px;"> <div style="border: 1px solid black; width: 20px; height: 20px;"></div> <div style="border: 1px solid black; width: 20px; height: 20px;"></div> </div>	CHANNEL PRIORITY	00 – DISABLED 01 – LOW PRIORITY 10 – MEDIUM PRIORITY 11 – HIGH PRIORITY	####E1C-####E1E
<div style="display: flex; justify-content: space-around; width: 100px;"> 0 </div> <div style="display: flex; justify-content: space-around; width: 100px;"> <div style="border: 1px solid black; width: 20px; height: 20px;"></div> </div>	CHANNEL INTERRUPT ENABLE	0 – CHANNEL INTERRUPTS DISABLED 1 – CHANNEL INTERRUPTS ENABLED	####E0A
<div style="display: flex; justify-content: space-around; width: 100px;"> 0 </div> <div style="display: flex; justify-content: space-around; width: 100px;"> <div style="background-color: gray; width: 20px; height: 20px;"></div> </div>	CHANNEL INTERRUPT STATUS	0 – CHANNEL INTERRUPT NOT ASSERTED 1 – CHANNEL INTERRUPT ASSERTED	####E20

PARAMETER RAM

	15	14	13	12	11	10	9	8	7	6	5	4	3	2	1	0
####F(W + 1)0	ACCEL_RATIO_2						ACCEL_RATIO_1									
####F(W + 1)2	ACCEL_RATIO_4						ACCEL_RATIO_3									
####F(W + 1)4	ACCEL_RATIO_6						ACCEL_RATIO_5									
####F(W + 1)6	ACCEL_RATIO_8						ACCEL_RATIO_7									
####F(W + 1)8	ACCEL_RATIO_10						ACCEL_RATIO_9									
####F(W + 1)A	ACCEL_RATIO_12						ACCEL_RATIO_11									
####F(W + 1)C *	ACCEL_RATIO_14 *						ACCEL_RATIO_13 *									
⋮	⋮						⋮									
####F(W + 3)A *	ACCEL_RATIO_36 *						ACCEL_RATIO_35 *									

* OPTIONAL ADDITIONAL PARAMETERS NOT AVAILABLE IN ALL CASES. REFER TO MOTOROLA PROGRAMMING NOTE TPUPN04 FOR DETAILS.

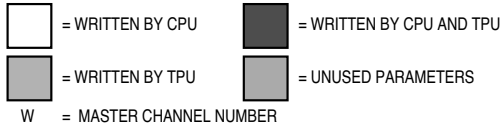

TPU TSM SLV CHRT

Figure A-17 TSM Parameters — Slave Mode

A.18 Frequency Measurement (FQM)

FQM counts the number of input pulses to a TPU channel during a user-defined window period. The function has single shot and continuous modes. No pulses are lost between sample windows in continuous mode. The user selects whether to detect pulses on the rising or falling edge. This function is intended for high speed measurement; measurement of slow pulses with noise rejection can be made with PTA.

Figure A-18 shows all of the host interface areas for the FQM function.

CONTROL BITS

	NAME	OPTIONS	ADDRESSES
0 <input type="checkbox"/>	CHANNEL INTERRUPT ENABLE	0 – CHANNEL INTERRUPTS DISABLED 1 – CHANNEL INTERRUPTS ENABLED	\$\$\$E0A
3 2 1 0 <input type="checkbox"/> <input type="checkbox"/> <input type="checkbox"/> <input type="checkbox"/>	CHANNEL FUNCTION SELECT	xxxx – FQD FUNCTION NUMBER (ASSIGNED DURING MICROCODE ASSEMBLY)	\$\$\$E0C-\$\$\$E12
1 0 <input type="checkbox"/> <input type="checkbox"/>	HOST SEQUENCE BITS	00 – BEGIN WITH FALLING EDGE, SINGLE-SHOT MODE 01 – BEGIN WITH FALLING EDGE, CONTINUOUS MODE 10 – BEGIN WITH RISING EDGE, SINGLE-SHOT MODE 11 – BEGIN WITH RISING EDGE, CONTINUOUS MODE	\$\$\$E14-\$\$\$E16
1 0 <input type="checkbox"/> <input type="checkbox"/>	HOST SERVICE BITS	00 – NO HOST SERVICE (RESET CONDITION) 01 – NOT USED 10 – INITIALIZE 11 – NOT USED	\$\$\$E18-\$\$\$E1A
1 0 <input type="checkbox"/> <input type="checkbox"/>	CHANNEL PRIORITY	00 – DISABLED 01 – LOW PRIORITY 10 – MEDIUM PRIORITY 11 – HIGH PRIORITY	\$\$\$E1C-\$\$\$E1E
0 <input type="checkbox"/>	CHANNEL INTERRUPT STATUS	0 – CHANNEL INTERRUPT NOT ASSERTED 1 – CHANNEL INTERRUPT ASSERTED	\$\$\$E20

PARAMETER RAM

	15	14	13	12	11	10	9	8	7	6	5	4	3	2	1	0
\$\$\$FW0																
\$\$\$FW2																
\$\$\$FW4	CHANNEL_CONTROL															
\$\$\$FW6	WINDOW_SIZE															
\$\$\$FW8	PULSE_COUNT															
\$\$\$FWA	IN_WINDOW_ACCUMULATOR															

<input type="checkbox"/>	= WRITTEN BY CPU	<input checked="" type="checkbox"/>	= WRITTEN BY CPU AND TPU
<input type="checkbox"/>	= WRITTEN BY TPU	<input type="checkbox"/>	= UNUSED PARAMETERS
W	= PRIMARY CHANNEL NUMBER		

TPU FQM CHRT

Figure A-18 FQM Parameters

A.19 Universal Asynchronous Receiver/Transmitter (UART)

The UART function uses one or two TPU channels to provide asynchronous communications. Data word length is programmable from 1 to 14 bits. The function supports detection or generation of even, odd, and no parity. Baud rate is freely programmable and can be higher than 100 Kbaud. Eight bidirectional UART channels running in excess of 9600 baud could be implemented on the TPU.

Figures A-19 and **A-20** show all of the host interface areas for the UART function in transmitting and receiving modes, respectively.

CONTROL BITS

	NAME	OPTIONS	ADDRESSES
<div style="display: flex; justify-content: space-around; width: 100px;"> 3210 </div> <div style="display: flex; justify-content: space-around; width: 100px;"> <div style="border: 1px solid black; width: 20px; height: 20px;"></div> <div style="border: 1px solid black; width: 20px; height: 20px;"></div> <div style="border: 1px solid black; width: 20px; height: 20px;"></div> <div style="border: 1px solid black; width: 20px; height: 20px;"></div> </div>	CHANNEL FUNCTION SELECT	UART FUNCTION NUMBER (ASSIGNED DURING MICRO-CODE ASSEMBLY)	\$\$\$E0C-\$\$\$E12
<div style="display: flex; justify-content: space-around; width: 100px;"> 10 </div> <div style="display: flex; justify-content: space-around; width: 100px;"> <div style="border: 1px solid black; width: 20px; height: 20px;"></div> <div style="border: 1px solid black; width: 20px; height: 20px;"></div> </div>	HOST SEQUENCE BITS	00 – NO PARITY 01 – NO PARITY 10 – EVEN PARITY 11 – ODD PARITY	\$\$\$E14-\$\$\$E16
<div style="display: flex; justify-content: space-around; width: 100px;"> 10 </div> <div style="display: flex; justify-content: space-around; width: 100px;"> <div style="border: 1px solid black; width: 20px; height: 20px;"></div> <div style="border: 1px solid black; width: 20px; height: 20px;"></div> </div>	HOST SERVICE BITS	00 – NOT USED 01 – NOT USED 10 – TRANSMIT 11 – RECEIVE	\$\$\$E18-\$\$\$E1A
<div style="display: flex; justify-content: space-around; width: 100px;"> 10 </div> <div style="display: flex; justify-content: space-around; width: 100px;"> <div style="border: 1px solid black; width: 20px; height: 20px;"></div> <div style="border: 1px solid black; width: 20px; height: 20px;"></div> </div>	CHANNEL PRIORITY	00 – DISABLED 01 – LOW PRIORITY 10 – MEDIUM PRIORITY 11 – HIGH PRIORITY	\$\$\$E1C-\$\$\$E1E
<div style="display: flex; justify-content: space-around; width: 100px;"> 0 </div> <div style="display: flex; justify-content: space-around; width: 100px;"> <div style="border: 1px solid black; width: 20px; height: 20px;"></div> </div>	CHANNEL INTERRUPT ENABLE	0 – CHANNEL INTERRUPTS DISABLED 1 – CHANNEL INTERRUPTS ENABLED	\$\$\$E0A
<div style="display: flex; justify-content: space-around; width: 100px;"> 0 </div> <div style="display: flex; justify-content: space-around; width: 100px;"> <div style="background-color: #cccccc; width: 20px; height: 20px;"></div> </div>	CHANNEL INTERRUPT STATUS	0 – CHANNEL INTERRUPT NOT ASSERTED 1 – CHANNEL INTERRUPT ASSERTED	\$\$\$E20

PARAMETER RAM (TRANSMITTER)

	15	14	13	12	11	10	9	8	7	6	5	4	3	2	1	0
\$\$\$FW0	PARITY_TEMP															
\$\$\$FW2	MATCH_RATE															
\$\$\$FW4	TDRE	TRANSMIT_DATA_REG														
\$\$\$FW6	DATA_SIZE															
\$\$\$FW8	ACTUAL_BIT_COUNT															
\$\$\$FWA	SHIFT_REGISTER															

	= WRITTEN BY CPU		= WRITTEN BY CPU AND TPU
	= WRITTEN BY TPU		= UNUSED PARAMETERS
W	= PRIMARY CHANNEL NUMBER		

TPU UART TRANS CHRT

Figure A-19 UART Transmitter Parameters

CONTROL BITS

	NAME	OPTIONS	ADDRESSES
<div style="display: flex; justify-content: space-around; width: 100px;"> 3210 </div> <div style="display: flex; justify-content: space-around; width: 100px;"> <div style="border: 1px solid black; width: 20px; height: 20px;"></div> <div style="border: 1px solid black; width: 20px; height: 20px;"></div> <div style="border: 1px solid black; width: 20px; height: 20px;"></div> <div style="border: 1px solid black; width: 20px; height: 20px;"></div> </div>	CHANNEL FUNCTION SELECT	UART FUNCTION NUMBER (ASSIGNED DURING MICRO-CODE ASSEMBLY)	###E0C-###E12
<div style="display: flex; justify-content: space-around; width: 100px;"> 10 </div> <div style="display: flex; justify-content: space-around; width: 100px;"> <div style="border: 1px solid black; width: 20px; height: 20px;"></div> <div style="border: 1px solid black; width: 20px; height: 20px;"></div> </div>	HOST SEQUENCE BITS	00 – NO PARITY 01 – NO PARITY 10 – EVEN PARITY 11 – ODD PARITY	###E14-###E16
<div style="display: flex; justify-content: space-around; width: 100px;"> 10 </div> <div style="display: flex; justify-content: space-around; width: 100px;"> <div style="border: 1px solid black; width: 20px; height: 20px;"></div> <div style="border: 1px solid black; width: 20px; height: 20px;"></div> </div>	HOST SERVICE BITS	00 – NOT USED 01 – NOT USED 10 – TRANSMIT 11 – RECEIVE	###E18-###E1A
<div style="display: flex; justify-content: space-around; width: 100px;"> 10 </div> <div style="display: flex; justify-content: space-around; width: 100px;"> <div style="border: 1px solid black; width: 20px; height: 20px;"></div> <div style="border: 1px solid black; width: 20px; height: 20px;"></div> </div>	CHANNEL PRIORITY	00 – DISABLED 01 – LOW PRIORITY 10 – MEDIUM PRIORITY 11 – HIGH PRIORITY	###E1C-###E1E
<div style="display: flex; justify-content: space-around; width: 100px;"> 0 </div> <div style="display: flex; justify-content: space-around; width: 100px;"> <div style="border: 1px solid black; width: 20px; height: 20px;"></div> </div>	CHANNEL INTERRUPT ENABLE	0 – CHANNEL INTERRUPTS DISABLED 1 – CHANNEL INTERRUPTS ENABLED	###E0A
<div style="display: flex; justify-content: space-around; width: 100px;"> 0 </div> <div style="display: flex; justify-content: space-around; width: 100px;"> <div style="background-color: #cccccc; border: 1px solid black; width: 20px; height: 20px;"></div> </div>	CHANNEL INTERRUPT STATUS	0 – CHANNEL INTERRUPT NOT ASSERTED 1 – CHANNEL INTERRUPT ASSERTED	###E20

PARAMETER RAM (RECEIVER)

	15	14	13	12	11	10	9	8	7	6	5	4	3	2	1	0
###FW0	PARITY_TEMP															
###FW2	MATCH_RATE															
###FW4	PE	FE	RECEIVE_DATA_REG													
###FW6	DATA_SIZE															
###FW8	ACTUAL_BIT_COUNT															
###FWA	SHIFT_REGISTER															

	= WRITTEN BY CPU		= WRITTEN BY CPU AND TPU
	= WRITTEN BY TPU		= UNUSED PARAMETERS
W	= PRIMARY CHANNEL NUMBER		

TPU UART REC CHRT

Figure A-20 UART Receiver Parameters

A.20 New Input Capture/Transition Counter (NITC)

Any channel of the TPU can capture the value of a specified TCR or any specified location in parameter RAM upon the occurrence of each transition or specified number of transitions, and then generate an interrupt request to notify the bus master. The times of the most recent two transitions are maintained in parameter RAM. A channel can perform input captures continually, or a channel can detect a single transition or specified number of transitions, ceasing channel activity until reinitialization. After each transition or specified number of transitions, the channel can generate a link to other channels.

Figure A-21 shows all of the host interface areas for the NITC function.

CONTROL BITS

	NAME	OPTIONS	ADDRESSES
3 2 1 0 <input type="checkbox"/> <input type="checkbox"/> <input type="checkbox"/> <input type="checkbox"/>	CHANNEL FUNCTION SELECT	NITC FUNCTION NUMBER (ASSIGNED DURING MICRO-CODE ASSEMBLY)	###E0C-###E12
1 0 <input type="checkbox"/> <input type="checkbox"/>	HOST SEQUENCE	00 – SINGLE-SHOT MODE, NO LINKS 01 – CONTINUOUS MODE, NO LINKS 10 – SINGLE-SHOT MODE, LINKS 11 – CONTINUOUS MODE, LINKS	###E14-###E16
1 0 <input type="checkbox"/> <input type="checkbox"/>	HOST SERVICE REQUEST	00 – NO HOST SERVICE (RESET CONDITION) 01 – INITIALIZE TCR MODE 10 – INITIALIZE PARAMETER MODE 11 – NOT USED	###E18-###E1A
1 0 <input type="checkbox"/> <input type="checkbox"/>	CHANNEL PRIORITY	00 – DISABLED 01 – LOW PRIORITY 10 – MEDIUM PRIORITY 11 – HIGH PRIORITY	###E1C-###E1E
0 <input type="checkbox"/>	CHANNEL INTERRUPT ENABLE	0 – CHANNEL INTERRUPTS DISABLED 1 – CHANNEL INTERRUPTS ENABLED	###E0A
0 <input checked="" type="checkbox"/>	CHANNEL INTERRUPT STATUS	0 – CHANNEL INTERRUPT NOT ASSERTED 1 – CHANNEL INTERRUPT ASSERTED	###E20

PARAMETER RAM

	15	14	13	12	11	10	9	8	7	6	5	4	3	2	1	0
###FW0									CHANNEL_CONTROL							
###FW2	START_LINK_CHANNEL				LINK_CHANNEL_COUNT				PARAM_ADDR				0			
###FW4	MAX_COUNT															
###FW6	TRANS_COUNT															
###FW8	FINAL_TRANS_TIME															
###FWA	LAST_TRANS_TIME															

<table style="width: 100%; border: none;"> <tr> <td style="width: 50%; text-align: center;"><input type="checkbox"/></td> <td>= WRITTEN BY CPU</td> </tr> <tr> <td style="text-align: center;"><input checked="" type="checkbox"/></td> <td>= WRITTEN BY CPU AND TPU</td> </tr> <tr> <td style="text-align: center;"><input checked="" type="checkbox"/></td> <td>= WRITTEN BY TPU</td> </tr> <tr> <td style="text-align: center;"><input type="checkbox"/></td> <td>= UNUSED PARAMETERS</td> </tr> </table>	<input type="checkbox"/>	= WRITTEN BY CPU	<input checked="" type="checkbox"/>	= WRITTEN BY CPU AND TPU	<input checked="" type="checkbox"/>	= WRITTEN BY TPU	<input type="checkbox"/>	= UNUSED PARAMETERS	<p>W = PRIMARY CHANNEL NUMBER</p>
<input type="checkbox"/>	= WRITTEN BY CPU								
<input checked="" type="checkbox"/>	= WRITTEN BY CPU AND TPU								
<input checked="" type="checkbox"/>	= WRITTEN BY TPU								
<input type="checkbox"/>	= UNUSED PARAMETERS								

TPU NITC CHRT

Figure A-21 NITC Parameters

A.21 Multiphase Motor Commutation (COMM)

The COMM function generates the phase commutation signals for a variety of brushless motors, including three-phase brushless direct current. It derives the commutation state directly from the position decoded in FQD, thus eliminating the need for hall effect sensors.

The state sequence is implemented as a user-configurable state machine, thus providing a flexible approach with other general applications. A CPU offset parameter is provided to allow all the switching angles to be advanced or retarded on the fly by the CPU. This feature is useful for torque maintenance at high speeds.

Figures A-22 and A-23 show all of the host interface areas for the COMM function.

CONTROL BITS

	NAME	OPTIONS	ADDRESSES
0 <input type="checkbox"/>	CHANNEL INTERRUPT ENABLE	0 – CHANNEL INTERRUPTS DISABLED 1 – CHANNEL INTERRUPTS ENABLED	###E0A
3 2 1 0 <input type="checkbox"/> <input type="checkbox"/> <input type="checkbox"/> <input type="checkbox"/>	CHANNEL FUNCTION SELECT	xxxx – FQD FUNCTION NUMBER (ASSIGNED DURING MICROCODE ASSEMBLY)	###E0C-###E12
1 0 <input type="checkbox"/> <input type="checkbox"/>	HOST SEQUENCE	00 – SENSORLESS MATCH UPDATE MODE 01 – SENSORLESS MATCH UPDATE MODE 10 – SENSORLESS LINK UPDATE MODE 11 – SENSORED MODE	###E14-###E16
1 0 <input type="checkbox"/> <input type="checkbox"/>	HOST SERVICE REQUEST	00 – NO HOST SERVICE (RESET CONDITION) 01 – NOT USED 10 – INITIALIZE OR FORCE STATE 11 – INITIALIZE OR FORCE IMMEDIATE STATE TEST	###E18-###E1A
1 0 <input type="checkbox"/> <input type="checkbox"/>	CHANNEL PRIORITY	00 – DISABLED 01 – LOW PRIORITY 10 – MEDIUM PRIORITY 11 – HIGH PRIORITY	###E1C-###E1E
0 <input type="checkbox"/>	CHANNEL INTERRUPT STATUS	0 – CHANNEL INTERRUPT NOTASSERTED 1 – CHANNEL INTERRUPT ASSERTED	###E20

PARAMETER RAM

	15	14	13	12	11	10	9	8	7	6	5	4	3	2	1	0
###FW0	START_LINK_CHANNEL						COUNTER_ADDR									
###FW2	NO_OF_STATES								STATE_NO							
###FW4	OFFSET															
###FW6	UPDATE_PERIOD															
###FW8	UPPER								LOWER							
###FWA																
###FWC																
###FWE																

= WRITTEN BY CPU = WRITTEN BY CPU AND TPU
 = WRITTEN BY TPU = UNUSED PARAMETERS
 W = MASTER COMM CHANNEL NUMBER

TPU COMM CHRT 1

Figure A-22 COMM Parameters, Part 1 of 2

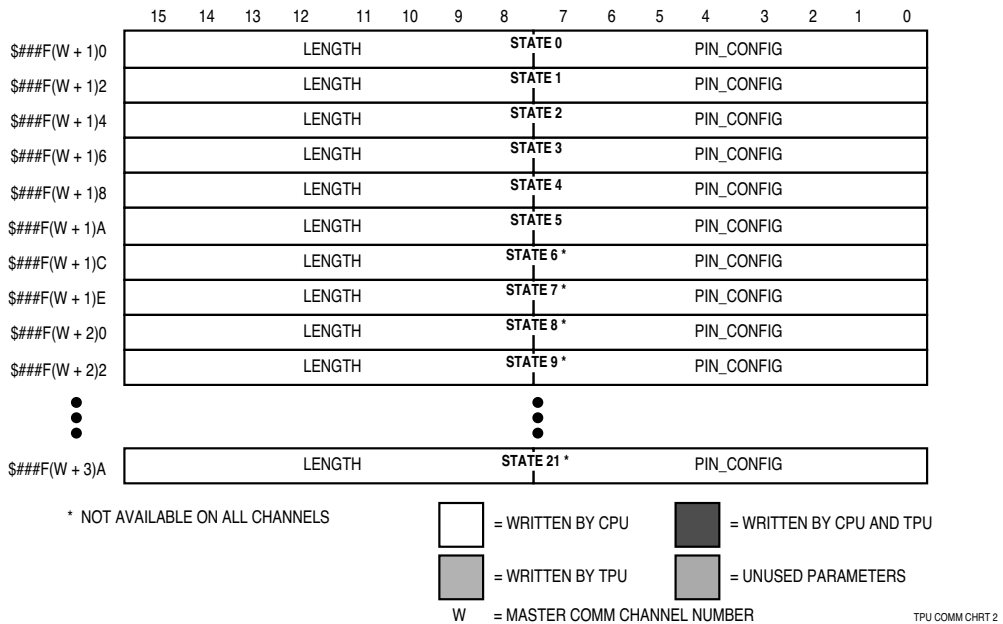

Figure A-23 COMM Parameters, Part 2 of 2

A.22 Multichannel Pulse-Width Modulation (MCPWM)

MCPWM generates pulse-width modulated outputs with full 0% to 100% duty cycle range independent of other TPU activity. This capability requires two TPU channels plus an external gate for one PWM channel. (A simple one-channel PWM capability is supported by the QOM function.)

Multiple PWMs generated by MCPWM have two types of high time alignment: edge aligned and center aligned. Edge-aligned mode uses $n + 1$ TPU channels for n PWMs; center-aligned mode uses $2n + 1$ channels. Center-aligned mode allows a user-defined “dead time” to be specified so that two PWMs can be used to drive an H-bridge without destructive current spikes. This feature is important for motor control applications.

Figures A-24 through A-29 show the host interface areas for the MCPWM function in each mode.

CONTROL BITS

	NAME	OPTIONS	ADDRESSES
0 <input type="checkbox"/>	CHANNEL INTERRUPT ENABLE	0 – CHANNEL INTERRUPTS DISABLED 1 – CHANNEL INTERRUPTS ENABLED	\$\$\$E0A
3 2 1 0 <input type="checkbox"/> <input type="checkbox"/> <input type="checkbox"/> <input type="checkbox"/>	CHANNEL FUNCTION SELECT	xxxx – FQD FUNCTION NUMBER (ASSIGNED DURING MICROCODE ASSEMBLY)	\$\$\$E0C–\$\$\$E12
1 0 <input type="checkbox"/> <input type="checkbox"/>	HOST SEQUENCE	00 – EDGE ALIGNED MODE 01 – SLAVE A TYPE CENTER ALIGNED MODE 10 – SLAVE B TYPE CENTER ALIGNED MODE 11 – SLAVE C TYPE CENTER ALIGNED MODE	\$\$\$E14–\$\$\$E16
1 0 <input type="checkbox"/> <input type="checkbox"/>	HOST SERVICE REQUEST	00 – NO HOST SERVICE (RESET CONDITION) 01 – INITIALIZE AS SLAVE (INVERTED) 10 – INITIALIZE AS SLAVE (NORMAL) 11 – INITIALIZE AS MASTER	\$\$\$E18–\$\$\$E1A
1 0 <input type="checkbox"/> <input type="checkbox"/>	CHANNEL PRIORITY	00 – DISABLED 01 – LOW PRIORITY 10 – MEDIUM PRIORITY 11 – HIGH PRIORITY	\$\$\$E1C–\$\$\$E1E
0 <input type="checkbox"/>	CHANNEL INTERRUPT STATUS	0 – CHANNEL INTERRUPT NOT ASSERTED 1 – CHANNEL INTERRUPT ASSERTED	\$\$\$E20

PARAMETER RAM

	15	14	13	12	11	10	9	8	7	6	5	4	3	2	1	0
\$\$\$FW0	PERIOD															
\$\$\$FW2	IRQ_RATE								PERIOD_COUNT							
\$\$\$FW4	LAST_RISE_TIME															
\$\$\$FW6	LAST_FALL_TIME															
\$\$\$FW8	RISE_TIME_PTR															
\$\$\$FWA	FALL_TIME_PTR															
\$\$\$FWC																
\$\$\$FWE																

<input type="checkbox"/>	= WRITTEN BY CPU	<input type="checkbox"/>	= WRITTEN BY CPU AND TPU
<input type="checkbox"/>	= WRITTEN BY TPU	<input type="checkbox"/>	= UNUSED PARAMETERS
W	= PRIMARY CHANNEL NUMBER		

TPU MCPWM MAS CHRT

Figure A-24 MCPWM Parameters — Master Mode

CONTROL BITS

	NAME	OPTIONS	ADDRESSES
<div style="display: flex; justify-content: space-around; width: 40px;"> 3210 </div> <div style="border: 1px solid black; width: 40px; height: 15px; margin-top: 5px;"></div>	CHANNEL FUNCTION SELECT	MCPWM FUNCTION NUMBER (ASSIGNED DURING MICRO-CODE ASSEMBLY)	\$\$\$E0C-\$\$\$E12
<div style="display: flex; justify-content: space-around; width: 40px;"> 10 </div> <div style="border: 1px solid black; width: 40px; height: 15px; margin-top: 5px;"></div>	HOST SEQUENCE	00 – EDGE ALIGNED MODE 01 – SLAVE A TYPE CENTER ALIGNED MODE 10 – SLAVE B TYPE CENTER ALIGNED MODE 11 – SLAVE C TYPE CENTER ALIGNED MODE	\$\$\$E14-\$\$\$E16
<div style="display: flex; justify-content: space-around; width: 40px;"> 10 </div> <div style="border: 1px solid black; width: 40px; height: 15px; margin-top: 5px;"></div>	HOST SERVICE REQUEST	00 – NO HOST SERVICE (RESET CONDITION) 01 – INITIALIZE AS SLAVE (INVERTED) 10 – INITIALIZE AS SLAVE (NORMAL) 11 – INITIALIZE AS MASTER	\$\$\$E18-\$\$\$E1A
<div style="display: flex; justify-content: space-around; width: 40px;"> 10 </div> <div style="border: 1px solid black; width: 40px; height: 15px; margin-top: 5px;"></div>	CHANNEL PRIORITY	00 – DISABLED 01 – LOW PRIORITY 10 – MEDIUM PRIORITY 11 – HIGH PRIORITY	\$\$\$E1C-\$\$\$E1E
<div style="display: flex; justify-content: space-around; width: 40px;"> 0 </div> <div style="border: 1px solid black; width: 40px; height: 15px; margin-top: 5px;"></div>	CHANNEL INTERRUPT ENABLE	0 – CHANNEL INTERRUPTS DISABLED 1 – CHANNEL INTERRUPTS ENABLED	\$\$\$E0A
<div style="display: flex; justify-content: space-around; width: 40px;"> 0 </div> <div style="background-color: #cccccc; border: 1px solid black; width: 40px; height: 15px; margin-top: 5px;"></div>	CHANNEL INTERRUPT STATUS	0 – CHANNEL INTERRUPT NOT ASSERTED 1 – CHANNEL INTERRUPT ASSERTED	\$\$\$E20

PARAMETER RAM

	15	14	13	12	11	10	9	8	7	6	5	4	3	2	1	0
\$\$\$FW0	PERIOD															
\$\$\$FW2	HIGH_TIME															
\$\$\$FW4																
\$\$\$FW6	HIGH_TIME_PTR															
\$\$\$FW8	RISE_TIME_PTR															
\$\$\$FWA	FALL_TIME_PTR															
\$\$\$FWC																
\$\$\$FWE																

= WRITTEN BY CPU
 = WRITTEN BY CPU AND TPU
 = WRITTEN BY TPU
 = UNUSED PARAMETERS
 W = PRIMARY CHANNEL NUMBER

TPU MCPWM S EA CHRT

Figure A-25 MCPWM Parameters — Slave Edge-Aligned Mode

CONTROL BITS

	NAME	OPTIONS	ADDRESSES
<div style="display: flex; justify-content: space-around; width: 40px;"> 3210 </div> <div style="border: 1px solid black; width: 40px; height: 15px; margin-top: 5px;"></div>	CHANNEL FUNCTION SELECT	MCPWM FUNCTION NUMBER (ASSIGNED DURING MICRO-CODE ASSEMBLY)	\$\$\$E0C-\$\$\$E12
<div style="display: flex; justify-content: space-around; width: 40px;"> 10 </div> <div style="border: 1px solid black; width: 40px; height: 15px; margin-top: 5px;"></div>	HOST SEQUENCE	00 – EDGE ALIGNED MODE 01 – SLAVE A TYPE CENTER ALIGNED MODE 10 – SLAVE B TYPE CENTER ALIGNED MODE 11 – SLAVE C TYPE CENTER ALIGNED MODE	\$\$\$E14-\$\$\$E16
<div style="display: flex; justify-content: space-around; width: 40px;"> 10 </div> <div style="border: 1px solid black; width: 40px; height: 15px; margin-top: 5px;"></div>	HOST SERVICE REQUEST	00 – NO HOST SERVICE (RESET CONDITION) 01 – INITIALIZE AS SLAVE (INVERTED) 10 – INITIALIZE AS SLAVE (NORMAL) 11 – INITIALIZE AS MASTER	\$\$\$E18-\$\$\$E1A
<div style="display: flex; justify-content: space-around; width: 40px;"> 10 </div> <div style="border: 1px solid black; width: 40px; height: 15px; margin-top: 5px;"></div>	CHANNEL PRIORITY	00 – DISABLED 01 – LOW PRIORITY 10 – MEDIUM PRIORITY 11 – HIGH PRIORITY	\$\$\$E1C-\$\$\$E1E
<div style="display: flex; justify-content: space-around; width: 40px;"> 0 </div> <div style="border: 1px solid black; width: 40px; height: 15px; margin-top: 5px;"></div>	CHANNEL INTERRUPT ENABLE	0 – CHANNEL INTERRUPTS DISABLED 1 – CHANNEL INTERRUPTS ENABLED	\$\$\$E0A
<div style="display: flex; justify-content: space-around; width: 40px;"> 0 </div> <div style="background-color: #cccccc; border: 1px solid black; width: 40px; height: 15px; margin-top: 5px;"></div>	CHANNEL INTERRUPT STATUS	0 – CHANNEL INTERRUPT NOT ASSERTED 1 – CHANNEL INTERRUPT ASSERTED	\$\$\$E20

PARAMETER RAM

	15	14	13	12	11	10	9	8	7	6	5	4	3	2	1	0
\$\$\$FW0	PERIOD															
\$\$\$FW2	NXT_B_RISE_TIME															
\$\$\$FW4	NXT_B_FALL_TIME															
\$\$\$FW6	DEAD_TIME								HIGH_TIME_PTR							
\$\$\$FW8	RISE_TIME_PTR															
\$\$\$FWA	FALL_TIME_PTR															
\$\$\$FWC																
\$\$\$FWE																

	= WRITTEN BY CPU		= WRITTEN BY CPU AND TPU
	= WRITTEN BY TPU		= UNUSED PARAMETERS
W = PRIMARY CHANNEL NUMBER			

TPU MCPWM SA NICA CHRT

Figure A-26 MCPWM Parameters — Slave Ch A Non-Inverted Center-Aligned Mode

CONTROL BITS

	NAME	OPTIONS	ADDRESSES
<div style="display: flex; justify-content: space-around; width: 40px;"> 3210 </div> <div style="border: 1px solid black; width: 40px; height: 15px; margin-top: 5px;"></div>	CHANNEL FUNCTION SELECT	MCPWM FUNCTION NUMBER (ASSIGNED DURING MICRO-CODE ASSEMBLY)	###E0C-###E12
<div style="display: flex; justify-content: space-around; width: 40px;"> 10 </div> <div style="border: 1px solid black; width: 40px; height: 15px; margin-top: 5px;"></div>	HOST SEQUENCE	00 – EDGE ALIGNED MODE 01 – SLAVE A TYPE CENTER ALIGNED MODE 10 – SLAVE B TYPE CENTER ALIGNED MODE 11 – SLAVE C TYPE CENTER ALIGNED MODE	###E14-###E16
<div style="display: flex; justify-content: space-around; width: 40px;"> 10 </div> <div style="border: 1px solid black; width: 40px; height: 15px; margin-top: 5px;"></div>	HOST SERVICE REQUEST	00 – NO HOST SERVICE (RESET CONDITION) 01 – INITIALIZE AS SLAVE (INVERTED) 10 – INITIALIZE AS SLAVE (NORMAL) 11 – INITIALIZE AS MASTER	###E18-###E1A
<div style="display: flex; justify-content: space-around; width: 40px;"> 10 </div> <div style="border: 1px solid black; width: 40px; height: 15px; margin-top: 5px;"></div>	CHANNEL PRIORITY	00 – DISABLED 01 – LOW PRIORITY 10 – MEDIUM PRIORITY 11 – HIGH PRIORITY	###E1C-###E1E
<div style="display: flex; justify-content: space-around; width: 40px;"> 0 </div> <div style="border: 1px solid black; width: 40px; height: 15px; margin-top: 5px;"></div>	CHANNEL INTERRUPT ENABLE	0 – CHANNEL INTERRUPTS DISABLED 1 – CHANNEL INTERRUPTS ENABLED	###E0A
<div style="display: flex; justify-content: space-around; width: 40px;"> 0 </div> <div style="background-color: gray; border: 1px solid black; width: 40px; height: 15px; margin-top: 5px;"></div>	CHANNEL INTERRUPT STATUS	0 – CHANNEL INTERRUPT NOT ASSERTED 1 – CHANNEL INTERRUPT ASSERTED	###E20

PARAMETER RAM

	15	14	13	12	11	10	9	8	7	6	5	4	3	2	1	0
###FW0	HIGH_TIME															
###FW2	CURRENT_HIGH_TIME															
###FW4	TEMP_STORAGE															
###FW6																
###FW8	B_FALL_TIME_PTR															
###FWA	B_RISE_TIME_PTR															
###FWC																
###FWE																

= WRITTEN BY CPU
 = WRITTEN BY CPU AND TPU
 = WRITTEN BY TPU
 = UNUSED PARAMETERS
 W = PRIMARY CHANNEL NUMBER

TPU MCPWM SB NICA CHRT

Figure A-27 MCPWM Parameters — Slave Ch B Non-Inverted Center-Aligned Mode

CONTROL BITS

	NAME	OPTIONS	ADDRESSES
<div style="display: flex; justify-content: space-around; width: 40px;"> 3210 </div> <div style="border: 1px solid black; width: 40px; height: 15px; margin-top: 5px;"></div>	CHANNEL FUNCTION SELECT	MCPWM FUNCTION NUMBER (ASSIGNED DURING MICRO-CODE ASSEMBLY)	\$\$\$E0C-\$\$\$E12
<div style="display: flex; justify-content: space-around; width: 40px;"> 10 </div> <div style="border: 1px solid black; width: 40px; height: 15px; margin-top: 5px;"></div>	HOST SEQUENCE	00 – EDGE ALIGNED MODE 01 – SLAVE A TYPE CENTER ALIGNED MODE 10 – SLAVE B TYPE CENTER ALIGNED MODE 11 – SLAVE C TYPE CENTER ALIGNED MODE	\$\$\$E14-\$\$\$E16
<div style="display: flex; justify-content: space-around; width: 40px;"> 10 </div> <div style="border: 1px solid black; width: 40px; height: 15px; margin-top: 5px;"></div>	HOST SERVICE REQUEST	00 – NO HOST SERVICE (RESET CONDITION) 01 – INITIALIZE AS SLAVE (INVERTED) 10 – INITIALIZE AS SLAVE (NORMAL) 11 – INITIALIZE AS MASTER	\$\$\$E18-\$\$\$E1A
<div style="display: flex; justify-content: space-around; width: 40px;"> 10 </div> <div style="border: 1px solid black; width: 40px; height: 15px; margin-top: 5px;"></div>	CHANNEL PRIORITY	00 – DISABLED 01 – LOW PRIORITY 10 – MEDIUM PRIORITY 11 – HIGH PRIORITY	\$\$\$E1C-\$\$\$E1E
<div style="display: flex; justify-content: space-around; width: 40px;"> 0 </div> <div style="border: 1px solid black; width: 40px; height: 15px; margin-top: 5px;"></div>	CHANNEL INTERRUPT ENABLE	0 – CHANNEL INTERRUPTS DISABLED 1 – CHANNEL INTERRUPTS ENABLED	\$\$\$E0A
<div style="display: flex; justify-content: space-around; width: 40px;"> 0 </div> <div style="background-color: #cccccc; border: 1px solid black; width: 40px; height: 15px; margin-top: 5px;"></div>	CHANNEL INTERRUPT STATUS	0 – CHANNEL INTERRUPT NOT ASSERTED 1 – CHANNEL INTERRUPT ASSERTED	\$\$\$E20

PARAMETER RAM

	15	14	13	12	11	10	9	8	7	6	5	4	3	2	1	0
\$\$\$FW0	PERIOD															
\$\$\$FW2	NXT_B_FALL_TIME															
\$\$\$FW4	NXT_B_RISE_TIME															
\$\$\$FW6	DEAD_TIME								HIGH_TIME_PTR							
\$\$\$FW8	FALL_TIME_PTR															
\$\$\$FWA	RISE_TIME_PTR															
\$\$\$FWC																
\$\$\$FWE																

	= WRITTEN BY CPU		= WRITTEN BY CPU AND TPU
	= WRITTEN BY TPU		= UNUSED PARAMETERS
W	= PRIMARY CHANNEL NUMBER		

TPU MCPWM SA ICA CHRT

Figure A-28 MCPWM Parameters — Slave Ch A Inverted Center-Aligned Mode

CONTROL BITS

	NAME	OPTIONS	ADDRESSES
<div style="display: flex; justify-content: space-around; width: 40px;"> 3210 </div> <div style="border: 1px solid black; width: 40px; height: 15px; margin-top: 5px;"></div>	CHANNEL FUNCTION SELECT	MCPWM FUNCTION NUMBER (ASSIGNED DURING MICRO-CODE ASSEMBLY)	\$\$\$E0C-\$\$\$E12
<div style="display: flex; justify-content: space-around; width: 40px;"> 10 </div> <div style="border: 1px solid black; width: 40px; height: 15px; margin-top: 5px;"></div>	HOST SEQUENCE	00 – EDGE ALIGNED MODE 01 – SLAVE A TYPE CENTER ALIGNED MODE 10 – SLAVE B TYPE CENTER ALIGNED MODE 11 – SLAVE C TYPE CENTER ALIGNED MODE	\$\$\$E14-\$\$\$E16
<div style="display: flex; justify-content: space-around; width: 40px;"> 10 </div> <div style="border: 1px solid black; width: 40px; height: 15px; margin-top: 5px;"></div>	HOST SERVICE REQUEST	00 – NO HOST SERVICE (RESET CONDITION) 01 – INITIALIZE AS SLAVE (INVERTED) 10 – INITIALIZE AS SLAVE (NORMAL) 11 – INITIALIZE AS MASTER	\$\$\$E18-\$\$\$E1A
<div style="display: flex; justify-content: space-around; width: 40px;"> 10 </div> <div style="border: 1px solid black; width: 40px; height: 15px; margin-top: 5px;"></div>	CHANNEL PRIORITY	00 – DISABLED 01 – LOW PRIORITY 10 – MEDIUM PRIORITY 11 – HIGH PRIORITY	\$\$\$E1C-\$\$\$E1E
<div style="display: flex; justify-content: space-around; width: 40px;"> 0 </div> <div style="border: 1px solid black; width: 40px; height: 15px; margin-top: 5px;"></div>	CHANNEL INTERRUPT ENABLE	0 – CHANNEL INTERRUPTS DISABLED 1 – CHANNEL INTERRUPTS ENABLED	\$\$\$E0A
<div style="display: flex; justify-content: space-around; width: 40px;"> 0 </div> <div style="background-color: gray; border: 1px solid black; width: 40px; height: 15px; margin-top: 5px;"></div>	CHANNEL INTERRUPT STATUS	0 – CHANNEL INTERRUPT NOT ASSERTED 1 – CHANNEL INTERRUPT ASSERTED	\$\$\$E20

PARAMETER RAM

	15	14	13	12	11	10	9	8	7	6	5	4	3	2	1	0
\$\$\$FW0	HIGH_TIME															
\$\$\$FW2	CURRENT_HIGH_TIME															
\$\$\$FW4	TEMP_STORAGE															
\$\$\$FW6																
\$\$\$FW8	B_FALL_TIME_PTR															
\$\$\$FWA	B_RISE_TIME_PTR															
\$\$\$FWC																
\$\$\$FWE																

= WRITTEN BY CPU
 = WRITTEN BY CPU AND TPU
 = WRITTEN BY TPU
 = UNUSED PARAMETERS
 W = PRIMARY CHANNEL NUMBER

TPU MCPWM SB ICA CHRT

Figure A-29 MCPWM Parameters — Slave Ch B Inverted Center-Aligned Mode

A.23 Hall Effect Decode (HALLD)

The HALLD function decodes the sensor signals from a brushless motor, along with a direction input from the CPU, into a state number. The function supports two- or three-sensor decoding. The decoded state number is written into a COMM channel, which outputs the required commutation drive signals. In addition to brushless motor applications, the function can have more general applications, such as decoding “option” switches.

Figure A-30 shows all of the host interface areas for the HALLD function.

CONTROL BITS

	NAME	OPTIONS	ADDRESSES
0 <input type="checkbox"/>	CHANNEL INTERRUPT ENABLE	0 – CHANNEL INTERRUPTS DISABLED 1 – CHANNEL INTERRUPTS ENABLED	\$\$\$E0A
3 2 1 0 <input type="checkbox"/> <input type="checkbox"/> <input type="checkbox"/> <input type="checkbox"/>	CHANNEL FUNCTION SELECT	xxxx – FQD FUNCTION NUMBER (ASSIGNED DURING MICROCODE ASSEMBLY)	\$\$\$E0C–\$\$\$E12
1 0 <input type="checkbox"/> <input type="checkbox"/>	HOST SEQUENCE	00 – CHANNEL A 01 – CHANNEL B 10 – CHANNEL B 11 – CHANNEL C (3-CHANNEL MODE ONLY)	\$\$\$E14–\$\$\$E16
1 0 <input type="checkbox"/> <input type="checkbox"/>	HOST SERVICE REQUEST	00 – NO HOST SERVICE (RESET CONDITION) 01 – NOT USED 10 – INITIALIZE, 2-CHANNEL MODE 11 – INITIALIZE, 3-CHANNEL MODE	\$\$\$E18–\$\$\$E1A
1 0 <input type="checkbox"/> <input type="checkbox"/>	CHANNEL PRIORITY	00 – DISABLED 01 – LOW PRIORITY 10 – MEDIUM PRIORITY 11 – HIGH PRIORITY	\$\$\$E1C–\$\$\$E1E
0 <input type="checkbox"/>	CHANNEL INTERRUPT STATUS	x – NOT USED	\$\$\$E20

PARAMETER RAM

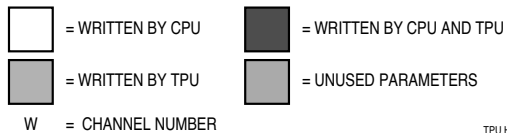
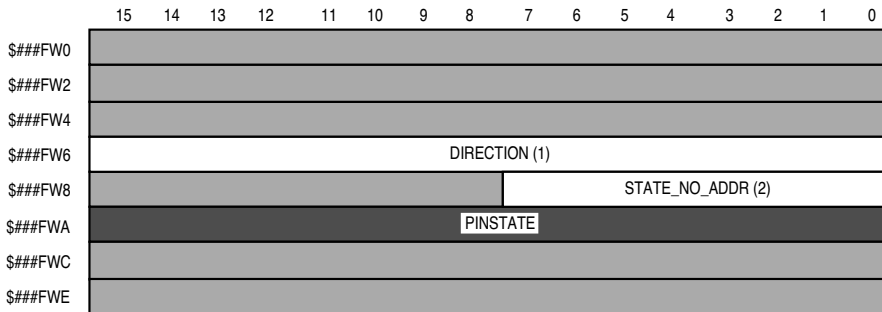

NOTES:
 1. CHANNEL A ONLY.
 2. 1 CHANNEL ONLY (CHANNEL B IN 2-CHANNEL MODE,
 CHANNEL C IN 3-CHANNEL MODE).

TPU HALLD CHRT

Figure A-30 HALLD Parameters

A.24 Fast Quadrature Decode TPU Function (FQD)

FQD is a position feedback function for motor control. It decodes the two signals from a slotted encoder to provide the CPU with a 16-bit free running position counter. FQD incorporates a “speed switch” which disables one of the channels at high speed, allowing faster signals to be decoded. A time stamp is provided on every counter update to allow position interpolation and better velocity determination at low speed or when low resolution encoders are used. The third index channel provided by some encoders is handled by the ITC function.

Figures A-31 and **A-32** show the host interface areas for the FQD function for primary and secondary channels, respectively.

CONTROL BITS

	NAME	OPTIONS	ADDRESSES
0 ■	CHANNEL INTERRUPT ENABLE	x – NOT USED	\$\$\$E0A
3 2 1 0 ■ ■ ■ ■	CHANNEL FUNCTION SELECT	xxxx – FQD FUNCTION NUMBER (ASSIGNED DURING MICROCODE ASSEMBLY)	\$\$\$E0C–\$\$\$E12
1 0 □ □	HOST SEQUENCE BITS	00 – PRIMARY CHANNEL (NORMAL MODE) 01 – SECONDARY CHANNEL (NORMAL MODE) 10 – PRIMARY CHANNEL (FAST MODE) 11 – SECONDARY CHANNEL (FAST MODE)	\$\$\$E14–\$\$\$E16
1 0 □ □	HOST SERVICE BITS	00 – NO HOST SERVICE (RESET CONDITION) 01 – NOT USED 10 – READ TCR1 11 – INITIALIZE	\$\$\$E18–\$\$\$E1A
1 0 □ □	CHANNEL PRIORITY	00 – DISABLED 01 – LOW PRIORITY 10 – MEDIUM PRIORITY 11 – HIGH PRIORITY	\$\$\$E1C–\$\$\$E1E
0 ■	CHANNEL INTERRUPT STATUS	xx – NOT USED	\$\$\$E20

PARAMETER RAM

	15	14	13	12	11	10	9	8	7	6	5	4	3	2	1	0
\$\$\$FW0	EDGE_TIME															
\$\$\$FW2	POSITION_COUNT															
\$\$\$FW4	TCR1_VALUE															
\$\$\$FW6	CHAN_PINSTATE															
\$\$\$FW8	CORR_PINSTATE_ADDR															
\$\$\$FWA	EDGE_TIME_LSB_ADDR															
\$\$\$FWC																
\$\$\$FWE																

□	= WRITTEN BY CPU	■	= WRITTEN BY CPU AND TPU
■	= WRITTEN BY TPU	■	= UNUSED PARAMETERS
W	= CHANNEL NUMBER		

TPU FQD PRI CHRT

Figure A-31 FQD Parameters — Primary Channel

CONTROL BITS

NAME	OPTIONS	ADDRESSES	
<div style="display: flex; justify-content: center; align-items: center;"> 0 <div style="width: 15px; height: 15px; background-color: #cccccc; border: 1px solid black;"></div> </div>	CHANNEL INTERRUPT ENABLE	x – NOT USED	\$\$\$E0A
<div style="display: flex; justify-content: center; align-items: center;"> 3 2 1 0 <div style="display: flex; gap: 5px;"> <div style="width: 15px; height: 15px; background-color: #cccccc; border: 1px solid black;"></div> <div style="width: 15px; height: 15px; background-color: #cccccc; border: 1px solid black;"></div> <div style="width: 15px; height: 15px; background-color: #cccccc; border: 1px solid black;"></div> <div style="width: 15px; height: 15px; background-color: #cccccc; border: 1px solid black;"></div> </div> </div>	CHANNEL FUNCTION SELECT	xxx – FQD FUNCTION NUMBER (ASSIGNED DURING MICROCODE ASSEMBLY)	\$\$\$E0C–\$\$\$E12
<div style="display: flex; justify-content: center; align-items: center;"> 1 0 <div style="display: flex; gap: 5px;"> <div style="width: 15px; height: 15px; background-color: #cccccc; border: 1px solid black;"></div> <div style="width: 15px; height: 15px; background-color: #cccccc; border: 1px solid black;"></div> </div> </div>	HOST SEQUENCE BITS	00 – PRIMARY CHANNEL (NORMAL MODE) 01 – SECONDARY CHANNEL (NORMAL MODE) 10 – PRIMARY CHANNEL (FAST MODE) 11 – SECONDARY CHANNEL (FAST MODE)	\$\$\$E14–\$\$\$E16
<div style="display: flex; justify-content: center; align-items: center;"> 1 0 <div style="display: flex; gap: 5px;"> <div style="width: 15px; height: 15px; background-color: #cccccc; border: 1px solid black;"></div> <div style="width: 15px; height: 15px; background-color: #cccccc; border: 1px solid black;"></div> </div> </div>	HOST SERVICE BITS	00 – NO HOST SERVICE (RESET CONDITION) 01 – NOT USED 10 – READ TCR1 11 – INITIALIZE	\$\$\$E18–\$\$\$E1A
<div style="display: flex; justify-content: center; align-items: center;"> 1 0 <div style="display: flex; gap: 5px;"> <div style="width: 15px; height: 15px; background-color: #cccccc; border: 1px solid black;"></div> <div style="width: 15px; height: 15px; background-color: #cccccc; border: 1px solid black;"></div> </div> </div>	CHANNEL PRIORITY	00 – DISABLED 01 – LOW PRIORITY 10 – MEDIUM PRIORITY 11 – HIGH PRIORITY	\$\$\$E1C–\$\$\$E1E
<div style="display: flex; justify-content: center; align-items: center;"> 0 <div style="width: 15px; height: 15px; background-color: #cccccc; border: 1px solid black;"></div> </div>	CHANNEL INTERRUPT STATUS	xx – NOT USED	\$\$\$E20

PARAMETER RAM

	15	14	13	12	11	10	9	8	7	6	5	4	3	2	1	0
\$\$\$F(W+1)0																
\$\$\$F(W+1)2																
\$\$\$F(W+1)4																
\$\$\$F(W+1)6																
\$\$\$F(W+1)8																
\$\$\$F(W+1)A																
\$\$\$F(W+1)C																
\$\$\$F(W+1)E																

= WRITTEN BY CPU
 = WRITTEN BY CPU AND TPU
 = WRITTEN BY TPU
 = UNUSED PARAMETERS
 W = PRIMARY CHANNEL NUMBER

TPU FQD SEC CHRT

Figure A-32 FQD Parameters — Secondary Channel

APPENDIX B MEMORY MAP AND REGISTERS

B.1 Memory Map

Table B-1 TPU Address Map

Access	Address	15	8 7	0
S ¹	####E00	TPU MODULE CONFIGURATION REGISTER (TPUMCR)		
S	####E02	TPU TEST CONFIGURATION REGISTER (TCR)		
S	####E04	DEVELOPMENT SUPPORT CONTROL REGISTER (DSCR)		
S	####E06	DEVELOPMENT SUPPORT STATUS REGISTER (DSSR)		
S	####E08	TPU INTERRUPT CONFIGURATION REGISTER (TICR)		
S	####E0A	CHANNEL INTERRUPT ENABLE REGISTER (CIER)		
S	####E0C	CHANNEL FUNCTION SELECT REGISTER 0 (CFSR0)		
S	####E0E	CHANNEL FUNCTION SELECT REGISTER 1 (CFSR1)		
S	####E10	CHANNEL FUNCTION SELECT REGISTER 2 (CFSR2)		
S	####E12	CHANNEL FUNCTION SELECT REGISTER 3 (CFSR3)		
S/U ²	####E14	HOST SEQUENCE REGISTER 0 (HSQR0)		
S/U	####E16	HOST SEQUENCE REGISTER 1 (HSQR1)		
S/U	####E18	HOST SERVICE REQUEST REGISTER 0 (HSRR0)		
S/U	####E1A	HOST SERVICE REQUEST REGISTER 1 (HSRR1)		
S	####E1C	CHANNEL PRIORITY REGISTER 0 (CPR0)		
S	####E1E	CHANNEL PRIORITY REGISTER 1 (CPR1)		
S	####E20	CHANNEL INTERRUPT STATUS REGISTER (CISR)		
S	####E22	LINK REGISTER (LR)		
S	####E24	SERVICE GRANT LATCH REGISTER (SGLR)		
S	####E26	DECODED CHANNEL NUMBER REGISTER (DCNR)		
S	####E28	TPU2 MODULE CONFIGURATION REGISTER 2 (TPUMCR2) — TPU2 ONLY		
S/U	###F00 – ###F0E	CHANNEL 0 PARAMETER REGISTERS		
S/U	###F10 – ###F1E	CHANNEL 1 PARAMETER REGISTERS		
S/U	###F20 – ###F2E	CHANNEL 2 PARAMETER REGISTERS		
S/U	###F30 – ###F3E	CHANNEL 3 PARAMETER REGISTERS		
S/U	###F40 – ###F4E	CHANNEL 4 PARAMETER REGISTERS		
S/U	###F50 – ###F5E	CHANNEL 5 PARAMETER REGISTERS		
S/U	###F60 – ###F6E	CHANNEL 6 PARAMETER REGISTERS		
S/U	###F70 – ###F7E	CHANNEL 7 PARAMETER REGISTERS		
S/U	###F80 – ###F8E	CHANNEL 8 PARAMETER REGISTERS		
S/U	###F90 – ###F9E	CHANNEL 9 PARAMETER REGISTERS		
S/U	###FA0 – ###FAE	CHANNEL 10 PARAMETER REGISTERS		
S/U	###FB0 – ###FBE	CHANNEL 11 PARAMETER REGISTERS		
S/U	###FC0 – ###FCE	CHANNEL 12 PARAMETER REGISTERS		
S/U	###FD0 – ###FDE	CHANNEL 13 PARAMETER REGISTERS		
S/U	###FE0 – ###FEE	CHANNEL 14 PARAMETER REGISTERS		
S/U	###FF0 – ###FFE	CHANNEL 15 PARAMETER REGISTERS		

NOTES:

1. S = Supervisor accessible only.
2. S/U = Supervisor accessible only (if SUPV = 1) or unrestricted (if SUPV = 0). Unrestricted registers allow both user and supervisor access.

B.2 Registers

The following section provides a summary of TPU registers and their contents.

B.2.1 TPU Module Configuration Register

TPUMCR — TPU Module Configuration Register **###E00**

15	14	13	12	11	10	9	8	7	6	5	4	3	2	1	0
STOP	TCR1P[1:0]		TCR2P[1:0]		EMU	T2CG	STF	SUPV	PSCK	TPU2 ¹	T2CSL ²	IARB[3:0]			
RESET:															
0	0	0	0	0	0	0	0	0	1	0	1	0	0	0	0

NOTES:

1. After reset, the TPU2 enable (TPU2) bit is zero if TPU module is present. In this case, the bit cannot be modified. If the TPU2 module is present, the TPU2 enable bit is one after reset.
2. After reset, TCR2 counter clock edge (T2CSL) bit is zero if the TPU module is present. In this case, the bit cannot be modified. If the TPU2 module is present, this bit is zero after reset and can be modified.

STOP — Stop Bit

- 0 = TPU operating normally
- 1 = Internal clocks shut down

TCR1P — Timer Count Register 1 Prescaler Control

TCR1 is clocked from the output of a prescaler. The input to the prescaler is the internal TPU system clock divided by either four or 32, depending on the value of the PSCK bit. The prescaler divides this input by one, two, four, or eight. In the TPU2, if the DIV2 bit is one, the TCR1 counter increments at a rate of the internal clock divided by two. If DIV2 is zero, TCR1 increment rate is defined by the values below.

- 00 = Divide by one
- 01 = Divide by two
- 10 = Divide by four
- 11 = Divide by eight

TCR2P — Timer Count Register 2 Prescaler Control

TCR2 is clocked from the output of a prescaler. The TCR2 field specifies the value of the prescaler: one, two, four, or eight.

- 00 = Divide by one
- 01 = Divide by two
- 10 = Divide by four
- 11 = Divide by eight

EMU — Emulation Control

- 0 = TPU and TPURAM in normal mode (operating as separate modules)
- 1 = TPU and TPURAM in emulation mode

After reset, this bit can be written only once.

When the TPU or TPU2 module is used with a flash EEPROM, the EMU bit is either set or cleared upon a reset according to the conditions shown in **Table B-2**.

Table B-2 TPU/TPU2 Reset with Flash EEPROM

Module	Reset Condition
TPU	EMU bit is cleared out of reset.
TPU2	If the shadow bit for bit four of the flash EEPROM module configuration register (FEEMCR) for the 4-Kbyte flash block is set, the EMU bit is cleared out of reset.
	If the shadow bit for bit four of the FEEMCR for the 4-Kbyte flash block is clear, the EMU bit is set out of reset.

T2CG — TCR2 Clock/Gate Control

In the TPU, the following states apply:

0 = TCR2 pin used as clock source for TCR2

1 = TCR2 pin used as gate of DIV8 clock for TCR2

In the TPU2, T2CG control bit and the T2CSL control bit determine the clock source for TCR2.

STF — Stop Flag

0 = TPU operating

1 = TPU stopped (STOP bit has been asserted)

SUPV — Supervisor Data Space

0 = Assignable registers are accessible from user or supervisor privilege level

1 = Assignable registers are accessible from supervisor privilege level only

PSCK — Prescaler Clock

0 = System clock/32 is input to TCR1 prescaler

1 = System clock/4 is input to TCR1 prescaler

TPU2 — TPU2 Enable

0 = TPU mode; zero is the TPU reset value.

1 = TPU2 mode; one is the TPU2 reset value.

T2CSL — TCR2 Counter Clock Edge

In the TPU2, this bit and the T2CG control bit determine the clock source for TCR2. Refer to **Table B-3**.

Table B-3 TCR2 Counter Clock Source

T2CSL	T2CG	TCR2 Clock
0	0	Rise transition T2CLK
0	1	Gated system clock
1	0	Fall transition T2CLK
1	1	Rise and fall transition T2CLK

IARB — Interrupt Arbitration Number

This field contains the TPU2 arbitration number that is used to arbitrate for the inter-module bus when two or more modules or peripherals have an interrupt on the same priority level. The highest arbitration priority is \$F, and the lowest is one. An IARB value of zero causes the TPU not to arbitrate for the intermodule bus during an interrupt-acknowledge cycle. Refer to **2.2.2 Interrupt Arbitration** for more information.

B.2.2 Test Configuration Register

TPUTCR — TPU Test Configuration Register

###E02

The TCR is used for factory test only.

B.2.3 Development Support Control Register

DSCR — Development Support Control Register

###E04

15	14	13	12	11	10	9	8	7	6	5	4	3	2	1	0
HOT4	0	0	0	0	BLC	CLKS	FRZ[1:0]	CCL	BP	BC	BH	BL	BM	BT	
RESET:															
0	0	0	0	0	0	0	0	0	0	0	0	0	0	0	0

HOT4 — Hang on T4

0 = Exit wait on T4 state caused by assertion of HOT4

1 = Enter wait on T4 state

BLC — Branch Latch Control

0 = Latch conditions into branch condition register before exiting halted state.

1 = Do not latch conditions into branch condition register before exiting the halted state or during the time-slot transition period.

CLKS — Stop Clocks (to TCRs)

0 = Do not stop TCRs.

1 = Stop TCRs during the halted state.

FRZ[1:0] — IMB FREEZE Response

The FRZ bits specify the TPU microengine response to the FREEZE signal. Refer to **Table B-4**.

Table B-4 FRZ[1:0] Bit Field

FRZ[1:0]	TPU Response
00	Ignore FREEZE
01	Reserved
10	FREEZE at end of current microcycle
11	FREEZE at next time-slot boundary

CCL — Channel Conditions Latch

CCL controls the latching of channel conditions (MRL and TDL) when the CHAN register is written.

0 = Only the pin state condition of the new channel is latched as a result of the write CHAN register microinstruction.

1 = Pin state, MRL, and TDL conditions of the new channel are latched as a result of a write CHAN register microinstruction.

BP, BC, BH, BL, BM, and BT — Breakpoint Enable Bits

DSCR[5:0] are TPU breakpoint enables. Setting a bit enables a breakpoint condition.

BP — Break if mPC equals mPC breakpoint register.

BC — Break if CHAN register equals channel breakpoint register at beginning of state

or when CHAN is changed through microcode.

BH — Break if host service latch is asserted at beginning of state.

BL — Break if link service latch is asserted at beginning of state.

BM — Break if MRL is asserted at beginning of state.

BT — Break if TDL is asserted at beginning of state.

B.2.4 Development Support Status Register

DSSR — Development Support Status Register

####E06

15	14	13	12	11	10	9	8	7	6	5	4	3	2	1	0
0	0	0	0	0	0	0	0	BKPT	PCBK	CHBK	SRBK	TPUF	0	0	0
RESET:															
0	0	0	0	0	0	0	0	0	0	0	0	0	0	0	0

BKPT — Breakpoint Asserted Flag

If an internal breakpoint caused the TPU to enter the halted state, the TPU asserts the BKPT signal on the IMB and the BKPT flag. The TPU continues to assert BKPT until it recognizes a breakpoint acknowledge cycle from a host, or until the FREEZE signal on the IMB is asserted.

PCBK — μ PC Breakpoint Flag

PCBK is asserted if a breakpoint occurs because of a μ PC register match with the μ PC breakpoint register. PCBK is negated when the BKPT flag is negated.

CHBK — Channel Register Breakpoint Flag

CHBK is asserted if a breakpoint occurs because of a CHAN register match with the channel register breakpoint register. CHBK is negated when the BKPT flag is negated.

SRBK — Service Request Breakpoint Flag

SRBK is asserted if a breakpoint occurs because of any of the service request latches being asserted along with their corresponding enable flag in the development support control register. SRBK is negated when the BKPT flag is negated.

TPUF — TPU FREEZE Flag

TPUF is asserted whenever the TPU is in a halted state as a result of FREEZE being asserted. This flag is automatically negated when the TPU exits the halted state because of FREEZE being negated.

B.2.5 TPU Interrupt Configuration Register

TICR — TPU Interrupt Configuration Register

####E08

15	14	13	12	11	10	9	8	7	6	5	4	3	2	1	0
0	0	0	0	0	CIRL			CIBV			0	0	0	0	
RESET:															
0	0	0	0	0	0	0	0	0	0	0	0	0	0	0	0

CIRL — Channel Interrupt Request Level

This three-bit encoded field specifies the interrupt request level for all channels. Level seven for this field indicates a non-maskable interrupt; level zero indicates that all channel interrupts are disabled.

CIBV — Channel Interrupt Base Vector

The TPU is assigned 16 unique interrupt vector numbers, one vector number for each channel. The CIBV field specifies the most significant nibble of all 16 TPU channel interrupt vector numbers. The lower nibble of the TPU interrupt vector number is determined by the channel number on which the interrupt occurs.

B.2.6 Channel Interrupt Enable Register

CIER — Channel Interrupt Enable Register

####E0A

15	14	13	12	11	10	9	8	7	6	5	4	3	2	1	0
CH 15	CH 14	CH 13	CH 12	CH 11	CH 10	CH 9	CH 8	CH 7	CH 6	CH 5	CH 4	CH 3	CH 2	CH 1	CH 0
RESET:															
0	0	0	0	0	0	0	0	0	0	0	0	0	0	0	0

CH[15:0] — Channel Interrupt Enable/Disable

0 = Channel interrupts disabled

1 = Channel interrupts enabled

B.2.7 Channel Function Select Registers

CFSR0 — Channel Function Select Register 0

####E0C

15	14	13	12	11	10	9	8	7	6	5	4	3	2	1	0
CHANNEL 15				CHANNEL 14				CHANNEL 13				CHANNEL 12			
RESET:															
0	0	0	0	0	0	0	0	0	0	0	0	0	0	0	0

CFSR1 — Channel Function Select Register 1

####E0E

15	14	13	12	11	10	9	8	7	6	5	4	3	2	1	0
CHANNEL 11				CHANNEL 10				CHANNEL 9				CHANNEL 8			
RESET:															
0	0	0	0	0	0	0	0	0	0	0	0	0	0	0	0

CFSR2 — Channel Function Select Register 2

####E10

15	14	13	12	11	10	9	8	7	6	5	4	3	2	1	0
CHANNEL 7				CHANNEL 6				CHANNEL 5				CHANNEL 4			
RESET:															
0	0	0	0	0	0	0	0	0	0	0	0	0	0	0	0

CFSR3 — Channel Function Select Register 3

####E12

15	14	13	12	11	10	9	8	7	6	5	4	3	2	1	0
CHANNEL 3				CHANNEL 2				CHANNEL 1				CHANNEL 0			
RESET:															
0	0	0	0	0	0	0	0	0	0	0	0	0	0	0	0

CHANNEL[15:0] — Function to Execute on Corresponding Channel

Each four-bit field within the channel function select registers specifies one of up to 16 time functions to be executed on the corresponding channel. Numbers for predefined functions in both TPU ROM mask sets currently in production are found in **Tables A-1** and **A-2**. Channel function select registers reside in supervisor data space.

B.2.8 Host Sequence Registers

HSQR0 — Host Sequence Register 0

####E14

15	14	13	12	11	10	9	8	7	6	5	4	3	2	1	0
CH 15	CH 14	CH 13	CH 12	CH 11	CH 10	CH 9	CH 8								
RESET:															
0	0	0	0	0	0	0	0	0	0	0	0	0	0	0	0

HSQR1 — Host Sequence Register 1

####E16

15	14	13	12	11	10	9	8	7	6	5	4	3	2	1	0
CH 7	CH 6	CH 5	CH 4	CH 3	CH 2	CH 1	CH 0								
RESET:															
0	0	0	0	0	0	0	0	0	0	0	0	0	0	0	0

CH[15:0] — Host Sequence Bits

The host sequence field helps specify the operation of the time function selected on a given channel. The meaning of the host sequence bits depends on the time function specified. Refer to **Tables A-1** and **A-2** for a summary of host sequence bits for the predefined functions in the two TPU ROM mask sets currently in production.

B.2.9 Host Service Request Registers

HSRR0 — Host Service Request Register 0

####E18

15	14	13	12	11	10	9	8	7	6	5	4	3	2	1	0
CH 15	CH 14	CH 13	CH 12	CH 11	CH 10	CH 9	CH 8								
RESET:															
0	0	0	0	0	0	0	0	0	0	0	0	0	0	0	0

HSRR1 — Host Service Request Register 1

####E1A

15	14	13	12	11	10	9	8	7	6	5	4	3	2	1	0
CH 7	CH 6	CH 5	CH 4	CH 3	CH 2	CH 1	CH 0								
RESET:															
0	0	0	0	0	0	0	0	0	0	0	0	0	0	0	0

CH[15:0] — Host Service Request

The host service request field selects the type of host service request for the time function selected on a given channel. The meaning of the host service request bits depends on the time function specified. Refer to **Tables A-1** and **A-2** for a summary of host service bits for the predefined functions in the two TPU ROM mask sets currently in production.

B.2.10 Channel Priority Registers

CPR0 — Channel Priority Register 0

####E1C

15	14	13	12	11	10	9	8	7	6	5	4	3	2	1	0
CH 15	CH 14	CH 13	CH 12	CH 11	CH 10	CH 9	CH 8								
RESET:															
0	0	0	0	0	0	0	0	0	0	0	0	0	0	0	0

CPR1 — Channel Priority Register 1

###E1E

15	14	13	12	11	10	9	8	7	6	5	4	3	2	1	0
CH 7	CH 6	CH 5	CH 4	CH 3	CH 2	CH 1	CH 0								
RESET:															
0	0	0	0	0	0	0	0	0	0	0	0	0	0	0	0

CH[15:0] — Priority Level

The channel priority registers (CPR0, CPR1) assign one of three priority levels to a channel or disable the channel. **Table B-5** indicates the priority assignments.

Table B-5 Channel Priorities

CHx[1:0]	Service
00	Disabled
01	Low
10	Middle
11	High

Access to the channel priority registers may generate a wait state (one clock delay of data transfer acknowledge assertion). The channel priority registers are accessible only from the supervisor privilege level.

B.2.11 Channel Interrupt Status Register

CISR — Channel Interrupt Status Register

###E20

15	14	13	12	11	10	9	8	7	6	5	4	3	2	1	0
CH 15	CH 14	CH 13	CH 12	CH 11	CH 10	CH 9	CH 8	CH 7	CH 6	CH 5	CH 4	CH 3	CH 2	CH 1	CH 0
RESET:															
0	0	0	0	0	0	0	0	0	0	0	0	0	0	0	0

CH[15:0] — Channel Interrupt Status Bit

- 0 = Channel interrupt not asserted
- 1 = Channel interrupt asserted

B.2.12 Link Register

LR — Link Register

###E22

15	14	13	12	11	10	9	8	7	6	5	4	3	2	1	0
CH 15	CH 14	CH 13	CH 12	CH 11	CH 10	CH 9	CH 8	CH 7	CH 6	CH 5	CH 4	CH 3	CH 2	CH 1	CH 0
RESET:															
0	0	0	0	0	0	0	0	0	0	0	0	0	0	0	0

CH[15:0] — Test Mode Link Service Request Enable Bit

- 0 = Link bit not asserted
- 1 = Link bit asserted

B.2.13 Service Grant Latch Register

SGLR — Service Grant Latch Register

###E24

15	14	13	12	11	10	9	8	7	6	5	4	3	2	1	0
CH 15	CH 14	CH 13	CH 12	CH 11	CH 10	CH 9	CH 8	CH 7	CH 6	CH 5	CH 4	CH 3	CH 2	CH 1	CH 0
RESET:															
0	0	0	0	0	0	0	0	0	0	0	0	0	0	0	0

CH[15:0] — Service Granted Bits

B.2.14 Decoded Channel Number Register

DCNR — Decoded Channel Number Register

###E26

15	14	13	12	11	10	9	8	7	6	5	4	3	2	1	0
CH 15	CH 14	CH 13	CH 12	CH 11	CH 10	CH 9	CH 8	CH 7	CH 6	CH 5	CH 4	CH 3	CH 2	CH 1	CH 0
RESET:															
0	0	0	0	0	0	0	0	0	0	0	0	0	0	0	0

CH[15:0] — Service Status Bits

B.2.15 TPUMCR2 Module Configuration Register 2

TPUMCR2 — TPU Module Configuration Register 2 (TPU2 Only)

###E28

15	14	13	12	11	10	9	8	7	6	5	4	3	2	1	0
0	0	0	0	0	0	0	DIV2	SOFT RST	ETBANK[1:0]	FPSCK[2:0]		T2CF	DTPU		
RESET:															
0	0	0	0	0	0	0	0	0	0	0	0	0	0	0	0

DIV2 — Divide by 2 Control

0 = TCR1 increments at rate determined by control bits in the TCR1P and PSCK fields of the TPUMCR register.

1 = Causes TCR1 counter to increment at a rate of the system clock divided by two.

SOFT RST — Soft Reset

0 = Normal operation

1 = Puts TPU2 in reset until bit is cleared

ETBANK[1:0] — Entry Table Bank Select

Refer to **Table B-6**.

Table B-6 Entry Table Bank Location

ETBANK	BANK
00	0
01	1
10	2
11	3

FPSCK[2:0] — Filter Prescaler Clock

Refer to **Table B-7**.

Table B-7 System Clock Frequency/Minimum Guaranteed Detected Pulse

Filter Control	Divide By	16.7 MHz	20 MHz
000	2	240 ns	200 ns
001	4	480 ns	400 ns
010	8	960 ns	800 ns
011	16	1.92 μ s	1.6 μ s
100	32	3.2 μ s	2.12 μ s
101	64	6.4 μ s	5.12 μ s
110	128	12.8 μ s	10.24 μ s
111	256	2.56 μ s	20.48 μ s

T2CF — T2CLK Pin Filter Control

0 = Uses fixed four-clock filter

1 = T2CLK input pin filtered with same filter clock that is supplied to the channels.

DTPU — Disable TPU2 Pins

0 = TP15 functions as normal TPU channel.

1 = TP15 pin configured as output disable pin. When TP15 pin is low, all TPU2 output pins are in a high-impedance state, regardless of the pin function.

B.2.16 TPU Parameter RAM

The channel parameter registers are organized as one hundred 16-bit words of RAM. In the TPU, channels 0 to 13 have six parameters; channels 14 and 15 each have eight parameters. In the TPU2, channels 0 through 15 each have eight parameters. The parameter RAM constitutes a shared work space for communication between the CPU and the TPU and provides data storage for the TPU. The TPU can only access data in the parameter RAM. Refer to **Table B-8**.

Table B-8 Parameter RAM Address Map

Channel Number	Parameter							
	0	1	2	3	4	5	6	7
0	00	02	04	06	08	0A	0C ¹	0E
1	10	12	14	16	18	1A	1C	1E
2	20	22	24	26	28	2A	2C	2E
3	30	32	34	36	38	3A	3C	3E
4	40	42	44	46	48	4A	4C	4E
5	50	52	54	56	58	5A	5C	5E
6	60	62	64	66	68	6A	6C	6E
7	70	72	74	76	78	7A	7C	7E
8	80	82	84	86	88	8A	8C	8E
9	90	92	94	96	98	9A	9C	9E
10	A0	A2	A4	A6	A8	AA	AC	AE
11	B0	B2	B4	B6	B8	BA	BC	BE
12	C0	C2	C4	C6	C8	CA	CC	CE
13	D0	D2	D4	D6	D8	DA	DC	DE
14	E0	E2	E4	E6	E8	EA	EC	EE
15	F0	F2	F4	F6	F8	FA	FC	FE

NOTES:

1. Shaded areas apply to the TPU2 only.

APPENDIX C ESTIMATING WORST-CASE LATENCY

Reliable systems are designed to work under worst-case conditions. This section explains how to estimate worst-case latency (WCL) for any TPU function in any system. The appendix covers the following topics:

- Introduction to Worst-Case Latency
- Using Worst-Case Latency Estimates to Evaluate Performance
- Priority Scheme Details used in WCL Analyses
- First-Pass WCL Analysis
- Second-Pass WCL Analysis

The first-pass WCL analysis is based on a deterministic, generalized formula that is easy to apply. Because of the generalizations in the formula, the first analysis result is almost always much worse than the real worst case. If the desired system performance is within the limits of this first analysis, then no further analysis is required; the system is well within the performance limits of the TPU. If the desired system performance exceeds that indicated by the first analysis, the second-pass WCL analysis should be applied. The second-pass analysis is not a generalized formula, but rather uses specific system details for a realistic worst-case estimation.

C.1 Introduction to Worst-Case Latency

Worst-case latency for a channel is the longest amount of time that can elapse between the execution of any two function states on that channel. For example, if in a particular system, channel 5 is running PWM, the worst-case latency for channel 5 is the longest possible time between the execution of two PWM states. The worst case time includes the time the execution unit takes to execute states for other active channels, and other delays described later in this appendix. Refer to **Figure C-1**.

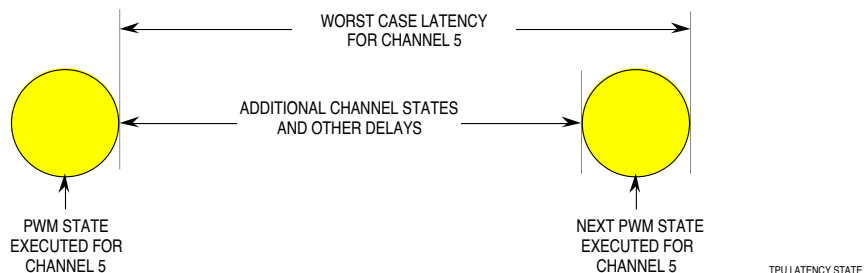

Figure C-1 Worst-Case Latency for PWM

Worst-case latency for a channel depends both on the function running on that channel and on the activity on other channels. Since the sixteen TPU channels must all share the same TPU execution unit, execution speed of a particular function varies with each system. The PWM runs faster if it is on the only active channel than if other channels are also active. In addition, changing the priority scheme and channel number assignments can change performance for a function even if the same set of functions are still active.

Each function is divided into states, as shown in **Figure C-2**. The TPU execution unit executes one state of a function at a time. For example, the execution unit might execute state 1 of PWM, then state 3 of DIO, then state 2 of PWM, then state 2 of SM, and so on. The amount of time the TPU execution unit grants a function to execute a state varies with the number of microcode instructions in the state.

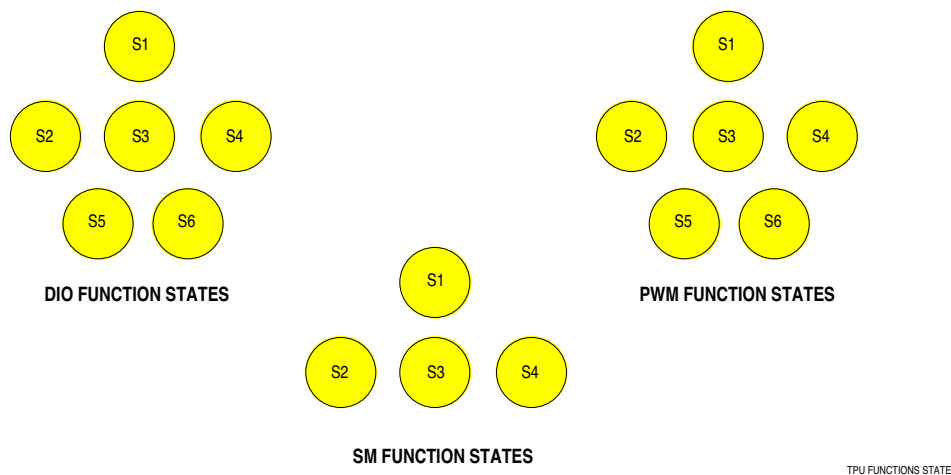

Figure C-2 TPU Function States

Since there is only one TPU execution unit, the TPU cannot actually execute the software for multiple functions simultaneously. However, the hardware for each of the sixteen channels is independent. This means that, for example, all sixteen channel pins can change state at the same moment, provided that the function software sets up the channel hardware to do so beforehand.

With CPU code, the system designer assigns functions to channels and initializes the functions. After initialization, functions typically run without CPU intervention, except for TPU channel interrupts to the CPU to give or receive information. Most functions can run continuously with periodic servicing from the TPU execution unit. As required, the channels request to be serviced from the TPU execution unit, and the TPU scheduler determines the order in which the channels are serviced. Worst-case latency for a channel can be derived from the details of the priority scheme that the scheduler uses.

C.2 Using Worst-Case Latency Estimates to Evaluate Performance

Once WCL is found for a channel, the user must determine how to use this number to analyze performance. To analyze the performance of a channel running the PWM function, for example, some information about what happens in each state is necessary.

For PWM, state 1 is the initialization state, and states 2 and 3 are used during normal function execution. (PWM states 4, 5, and 6 are for special modes and will be assumed to be unused on channel 5.) State 2 writes a time into the channel 5 match register and performs other operations that will cause the channel 5 pin to go from low to high at the time indicated in the match register (match time). At match time, the pin goes high and channel 5 requests service from the TPU execution unit to execute state 3. State 3 writes a time into the channel 5 match register and performs other operations that will cause the channel 5 pin to go from high to low at match time. At match time, the pin goes low and channel 5 requests service from the TPU execution unit to execute state 2. A PWM wave is kept running on the system by the TPU executing state 2, then state 3, then state 2, then state 3, and so on.

Since the definition of worst-case latency assumes a fully loaded running system, initialization states are not part of worst-case calculations. For the channel 5 example, the two PWM states in **Figure C-1** are thus the two normal running states, states 2 and 3.

Figure C-1 does not define which state is state 2 and which is state 3. Since the worst-case latency derived from the first-pass analysis is the worst case between *any 2* states (not counting initialization states), it is safe to say that the worst-case latency shown in **Figure C-2** represents both the worst-case high time and the worst-case low time.

Notice in **Figure C-2** that worst-case latency is drawn from the end of the execution of the first PWM state to the end of the execution of the next PWM state. It is drawn from end to end because the microcode instructions that make up the states control the channel hardware. To make sure that all the microcode instructions needed to change the pin state have been executed, it is necessary to include the execution time of the second state.

State information for each function is found in the programming notes for individual TPU functions. Refer to Motorola Programming Note TPUPN00/D, *Using the TPU Function Library and TPU Emulation Mode*, for a list of available programming notes.

C.3 Priority Scheme Details Used in WCL Analysis

The user assigns functions to channel numbers and gives each active channel a priority level of high, middle, or low. The scheduler uses the channel number and channel priority level to determine the order in which to grant service.

The scheduler allocates time slots to specific priority levels of high, middle, or low. One function state is executed in each time slot. The length of a time slot varies according to the length of the executing state. The scheduler always assigns time slots in a sev-

en-slot sequence. Refer to **Figure C-3**. After a seven-slot sequence is completed, another seven-slot sequence begins. Refer to **Figure C-4**.

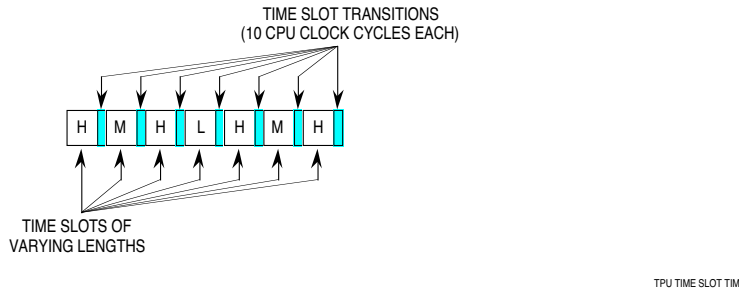

Figure C-3 Time-Slot Sequence

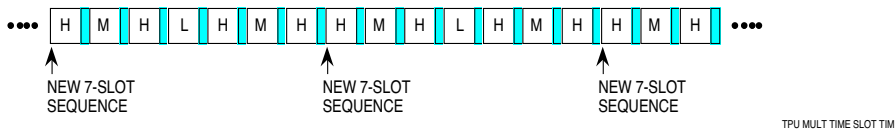

Figure C-4 Multiple Time-Slot Sequences

This fixed-sequence scheme gives higher-priority channels more service time than lower-priority channels. High-priority channels are allocated four of seven time slots, middle-priority channels are allocated two of seven time slots, and low-priority channels are allocated one of seven time slots.

C.3.1 Priority Passing

If no channel of the priority level assigned to the time slot is requesting service, the TPU scheduler can pass priority to other levels. If no high-level channel is requesting service during a high level time slot, a middle-level channel is granted service; or, if no middle level-channel is requesting service, a low-level channel is granted service. If no middle-level channel is requesting service during a middle-level time slot, a high-level channel is granted service; or, if no high-level channel is requesting service, a low-level channel is granted service. If no low-level channel is requesting service during a low-level time slot, a high-level channel is granted service; or, if no high-level channel is requesting service, a middle-level channel is granted service. If no channel is requesting service, the scheduler idles at the current time slot until a request is received.

Priority passing is implemented in hardware and does not contribute to worst-case latency.

C.3.2 Time-Slot Transition

After each time slot, the TPU must prepare for the next time slot. This preparation time between each time slot is called a time-slot transition. Refer to **Figure C-3**. Time-slot transitions always take ten CPU clocks.

C.3.3 Channel Number Priority

If more than one channel of a priority level is requesting service, the lowest numbered channel is granted service first. For example, if channels 0, 5, and 9 are all high-level channels requesting service during a high time slot, channel 0 is granted service first. Continuing this example, if channel 0 requests service again immediately after being serviced, it is not serviced again until channels 5 and 9 are serviced. This scheme is implemented so that continuously-requesting low numbered channels do not take all the time on the TPU execution unit and leave no time for other channels.

The scheduler uses latches to keep track of which channels have been serviced and which require servicing. Each channel has two latches: a service request latch (SRL) and a service grant latch (SGL). The SRL is set when a channel requests service. After the channel has been granted service, the SGL is set and the SRL is cleared.

SGLs are not cleared individually by channel, but rather as priority level groups. The clearing of a group of SGLs begins a new cycle for that priority level. An SGL group is cleared on the condition that a channel of that priority level has just been serviced, and no other channel of that priority level is requesting service (has a set SRL) and has not been granted service (has a clear SGL).

For example, if a middle-priority channel has just been serviced (either in a middle-priority time slot or a high or low-priority time slot gained by priority passing), the SRLs and SGLs of all middle-priority channels are compared. If there is no middle-priority channel with its SRL set and SGL cleared, the scheduler clears all middle-level SGLs. If there is a middle-level channel with its SRL set and SGL cleared, the scheduler does not clear the SGL group, and the requesting middle-level channel is serviced on the next middle-level time slot (or possibly sooner by priority passing).

While it is clearing a group of SGLs, the TPU issues a 4-clock no operation (NOP). This four clock delay must be included in worst case latency estimations as appropriate.

C.3.4 RAM Collision Rate

Most function states read or write to the TPU parameter RAM at least once. Because both the TPU and CPU can access the parameter RAM but not at the same time, the TPU may stall during a parameter RAM access while waiting for the CPU to finish accessing the RAM. At other times the CPU may stall for the TPU. A stall can take up to two CPU clocks. TPU stalls must be added into the worst-case latency calculation. The system designer should estimate the percentage of parameter RAM accesses in the system that will result in a TPU stall. This percentage is called the RAM collision rate (RCR).

A 100% RCR for a system is the theoretical worst case. In many systems, however, the RCR is very low, sometimes even near 0%. This is because the TPU is an independent processor capable of servicing most function needs, so that the CPU rarely needs to access the TPU parameter RAM. To find a realistic RCR, the system designer should evaluate the CPU code and find the percentage of time it accesses the TPU parameter RAM. This percentage is a good RCR.

NOTE

The programming practice of polling a flag in the TPU parameter RAM causes a very high RCR and should be avoided in high-performance systems.

After a RAM collision rate for a system is found, it can be applied to the WCL calculations for each channel. The system designer can use the RCR and the number of RAM accesses in the longest state to estimate the TPU stall time for a function. The estimation of TPU stall time is as follows:

$$\text{Function TPU stall time} = \text{Number of RAM accesses in the longest state} \times \text{RCR} \times 2 \text{ CPU clocks}$$

C.4 First-Pass Worst-Case Latency Analysis

Following is the “first-pass” calculation of worst-case latency for a channel. Remember that this analysis uses generalizations that usually produce a result much worse than the real worst case. If the worst-case result from the first analysis is too long for the desired performance, use the second analysis for a more realistic worst-case analysis.

C.4.1 Worst-Case Assumptions and Formula

To estimate worst-case latency for a channel, assume this worst-case condition: the channel has just been serviced in a time slot of its priority level, and all other channels in the system are continuously requesting service and have cleared SGLs. The worst-case latency is the time from the end of the channel's service until the end of the channel's next service. See **Figure C-5**.

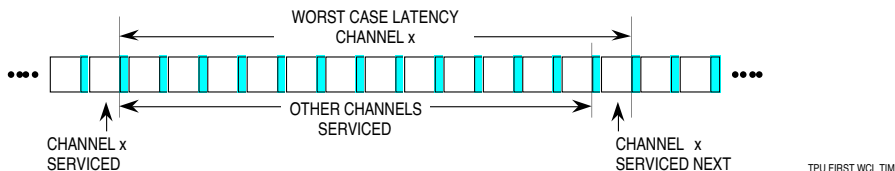

Figure C-5 First-Pass Worst-Case Latency

To estimate worst-case latency:

- Find the worst-case service time for each active channel.
- Using the H-M-H-L-H-M-H time-slot sequence, map the channels that are granted for each time slot.
- Add time for ten-clock time-slot transitions and four-clock NOPs.

C.4.1.1 Finding the Worst-Case Service Time for Each Active Channel

Table C-1 lists the longest states (not counting initialization states) for the functions from the first TPU mask. **Table C-1** also includes the number of TPU parameter RAM accesses in the longest state, which is used in estimating TPU stall time. **Table C-1** is referenced in the examples in this section.

Table C-1 Longest States and RAM Accesses for Mask Set A Functions

Function	Longest State	RAM Accesses
DIO	10	4
ITC	40 (no linking) 42 (linking)	7
OC	40	7
PWM	24	4
SPWM		
Mode 0	14	4
Mode 1	18	4
Mode 2	20 (no linking) 22 (linking)	4 4
PMA	94	8
PMM	94	8
PSP		
Angle-Angle Mode	76	6
Angle-Time Mode	50	3
SM ¹	160	21
PPWA		
Mode 0	44	9
Mode 1	50 ²	10
Mode 2	44	9
Mode 3	50	10

NOTES:

1. Assumes one master and one slave. For each additional slave
 - a) Add 32 clocks and 2 RAM accesses, and
 - b) Add (STEP_RATE_CNT * two clocks)
2. With one channel linked. Add two clocks for each additional channel linked.

The worst-case service time for each channel is:

$$\text{Longest state} + (\text{number of RAM accesses in longest state} \times \text{RCR} \times 2 \text{ clocks})$$

C.4.1.2 Mapping the Channels for Each Time Slot

To determine when a channel will be serviced again, it is necessary to determine which other channels will be serviced first. Do this by assuming all channels are continuously requesting service and mapping the channels into the time-slot sequence.

C.4.1.3 Adding Time for Time-Slot Transitions and NOPs

Add time for time-slot transitions which occur after each time slot and four-clock NOPs which occur when the TPU clears a group of SGLs to start a new cycle for a priority level.

C.4.2 First-Pass Analysis Worst-Case Latency Examples

The examples in this section assume the system configuration shown in **Table C-2**.

Table C-2 System Configuration Example

Channel	Priority	Function ^{1, 2}
0	High	PWM (driving a DC motor)
1	Middle	PPWA (Mode 0, measuring the DC motor speed)
2	Low	DIO (Input)

NOTES:

1. 9% RAM Collision Rate (RCR)
2. CPU clock rate = 16.67 MHz, or 60 ns per clock period

C.4.2.1 Finding the WCL for PWM on Channel 0

Find the worst-case service time for each active channel.

1. Longest state of PWM is 24 CPU clocks with four RAM accesses.
 $24 + (4 \text{ RAM accesses} \times .09 \times 2 \text{ CPU clock stalls}) = 24.72 \text{ CPU clocks}$, rounded up to 25 CPU clocks (since there are no partial clock periods)

Channel 0 worst-case service time = 25 CPU clocks.
2. Longest state of PPWA in mode 0 is 44 CPU clocks with nine RAM accesses.
 $44 + (9 \text{ RAM accesses} \times .09 \times 2 \text{ CPU clock stalls}) = 45.62 \text{ CPU clocks}$, rounded up to 46 CPU clocks

Channel 1 worst-case service time = 46 CPU clocks.
3. Longest state of DIO is ten CPU clocks with four RAM accesses.
 $10 + (4 \text{ RAM accesses} \times .09 \times 2 \text{ CPU clock stalls}) = 10.72 \text{ CPU clocks}$, rounded up to 11 CPU clocks

Channel 2 worst-case service time = 11 CPU clocks.
4. Assume channel 0 has just been serviced and that channels 1 and 2 are continuously requesting service. Using the H-M-H-L-H-M-H time-slot sequence, map the channels that are granted for each time slot. See **Figure C-6**.

= 10-CYCLE TIME SLOT TRANSITION
 = 4-CYCLE NOP INSTRUCTION

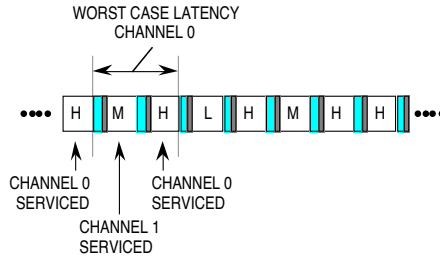

TPU CH0 WCL TIM

Figure C-6 Next Servicing for Channel 0

Channel 1 will be serviced in the middle-priority time slot before channel 0 is serviced again.

5. Add time for the ten-clock CPU time-slot transitions and the four-clock NOPs. Refer to **Figure C-6** and **Table C-3**.

A four-clock NOP occurs after each channel is serviced since there is one channel in each priority level, i.e., a new cycle for a priority level is started after each channel is serviced. Time-slot transitions occur after each time slot.

Table C-3 Worst-Case Latency for Channel 0

Channel 0 worst-case service time	25 clocks
Channel 1 worst-case service time	46 clocks
Two 10-clock time-slot transitions	20 clocks
Two 4-clock NOPs	8 clocks
Total clocks	99 clocks



$$99 \text{ clocks} \times 60 \text{ ns/clock} = 5940 \text{ ns}$$

Conclusion: in this system configuration PWM can run with a minimum high time or low time of 5940 ns.

C.4.2.2 Finding the WCL for PPWA on Channel 1

Find the worst-case service time for each active channel. See step 1 of previous example.

1. Assume channel 1 has just been serviced and that channels 0 and 2 are continuously requesting service. Using the H-M-H-L-H-M-H time-slot sequence, map the channels that are granted for each time slot. See **Figure C-7**.

 = 10-CYCLE TIME SLOT TRANSITION
 = 4-CYCLE NOP INSTRUCTION

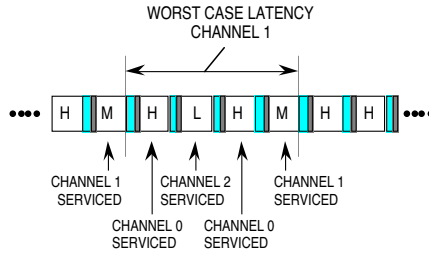

TPU CH1 WCL TIM

Figure C-7 Next Servicing for Channel 1

Channel 0 will be serviced twice and channel 2 once before channel 1 is serviced again.

2. Add time for the ten-clock CPU time-slot transitions and the four-clock NOPs. Refer to **Figure C-7** and **Table C-4**.

Table C-4 Worst Case Latency for Channel 1

Two Channel 0 worst-case service times	50 clocks
Channel 1 worst-case service time	46 clocks
Channel 2 worst-case service time	11 clocks
Four 10-clock time-slot transitions	40 clocks
Four 4-clock NOPs	16 clocks
Total clocks	163 clocks

$$163 \text{ clocks} \times 60 \text{ ns/clock} = 9780 \text{ ns}$$

Conclusion: in this system configuration PPWA can measure a period or pulse of minimum 9780 ns.

C.4.2.3 Finding the WCL for DIO on Channel 2

Find the worst-case service time for each active channel. See step 1 of previous examples.

1. Assume channel 2 has just been serviced and that channels 0 and 1 are continuously requesting service. Using the H-M-H-L-H-M-H time-slot sequence, map the channels that are granted for each time slot. See **Figure C-8**.

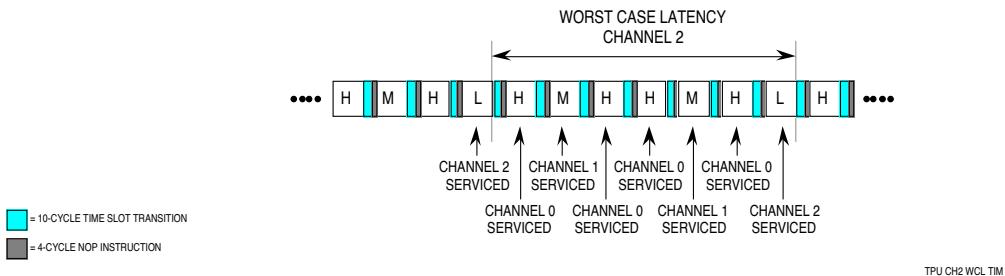

Figure C-8 Next Servicing for Channel 2

Channel 0 will be serviced four times and channel 1 twice before channel 2 is serviced again.

2. Add time for the ten-clock CPU time-slot transitions and the four-clock NOPs. See **Figure C-8** and **Table C-5**.

Table C-5 Worst Case Latency for Channel 2

Four Channel 0 worst-case service times	100 clocks
Two Channel 1 worst-case service time	92 clocks
Channel 2 worst-case service time	11 clocks
Seven 10-clock time-slot transitions	70 clocks
Seven 4-clock NOPs	28 clocks
Total clocks	301 clocks

$$301 \text{ clocks} \times 60 \text{ ns/clock} = 18060 \text{ ns}$$

Conclusion: in this system configuration DIO can keep track of the input level at a minimum of every 18060 ns.

C.5 Second-Pass Worst-Case Latency Analysis

Following is an example of a “second-pass” analysis for calculating worst-case latency for a channel. The second-pass analysis is useful for higher-performance systems, since it gives a more realistic worst-case latency result than first-pass analysis.

This example uses a relatively simple system in order to illustrate the basic principles of second-pass analysis. For a more complex example of second-pass analysis, refer to *Multiphase Motor Commutation TPU Function (COMM)* (TPUPN09/D).

C.5.1 Second-Pass Analysis Guidelines

Rather than use a fixed formula, a second-pass analysis relies on the application of the following guidelines.

1. The first-pass analysis makes the assumption that all channels in the system are continually requesting service. For many systems this is an unrealistic assumption. For example, if TCR1 is counting at a rate of 2 MHz (500 ns per count) and a channel is running the DIO function with a match rate of 20,000 TCR1 counts, the DIO will request service every 10 ms (20,000 × 500 ns = 10,000,000 ns or 10 ms). It is therefore unrealistic to assume that the channel running this DIO function is continuously requesting service. Figure out a realistic service request rate for each channel. Time slots can then be mapped to each channel at the real rate of request.
2. If a function is active during system initialization but not during the high-speed “running mode” of the system, then that system does not need to be included in the high-speed worst-case latency calculations.
3. Use a realistic RAM collision rate.
4. Be careful when assigning functions priority levels and channel numbers. Decide which function or functions will be most difficult to make perform at the desired level. Assign those channels high priority and low channel numbers. Try different priority and channel assignments to see how it affects the system.
5. The seven-slot sequence of || H | M | H | L | H | M | H || is asymmetrical when put back-to-back with other seven-slot sequences. Note that in the following sequence there are two high-priority slots next to each other:

|| H | M | H | L | H | M | H || || H | M | H | L | H | M | H ||

Make sure that when mapping out channels to the sequence, you choose a worst-case slot to start the mapping. For example, when estimating WCL for a high-priority channel, do not start the mapping in the last high-priority slot in a seven-slot sequence, as that is a best case for a high-priority channel since another high-priority time slot is next.

6. Instead of always using the longest state in the function as the worst-case state, evaluate the states in the function that will be used in the system and use the appropriate worst-case states. For example, in the preceding example of first-pass analysis, the PWM was shown to be able to achieve a high time and low time of 5940 ns under worst-case conditions. This was derived using the longest PWM state of 24 CPU clocks. This longest state is actually state 2, the state that is entered after the pin has just gone high. State 3, the state that is entered after the pin has just gone low, requires only 2 CPU clocks. Therefore, in the first-pass example, the high time was correctly derived, but the low time is actually shorter than was estimated.

C.5.2 Second-Pass Analysis Example

This example requires three 50% PWM waveforms: one 5 kHz (200 μs/period) and two 50 MHz (20 μs/period), each running DC motors. (Remember that the PWM function requests service from the TPU after each high time and after each low time, so the TPU must handle a request every 100 μs for the 5 kHz PWM and every 10 μs for the 50 MHz PWM.)

NOTE

This example uses square waves for simplicity. Notice that to use a PWM waveform in the typical way, in which the pulse is modulated, the pulse must not be modulated in a way that violates the worst-case latency requirements.

This example also uses one DIO channel monitoring a signal level every millisecond and one PPWA channel in mode 0 monitoring the speed of the 5-kHz DC motor. The PPWA must measure periods of 5 kHz (200 μ s/period).

The CPU is interrupted by the channel running the PPWA function after measuring 200 periods (every 40 ms). The interrupt service routine performs an averaging of the period accumulation and checks it against a known parameter. The interrupt service time is so short and infrequent that it is a tiny fraction of total system time. The interrupt service routine contains no polling of the parameter RAM. Therefore a realistic RCR = 0%.

C.5.2.1 First-Try System Configuration

Try a system configuration that seems likely to work. If it does not, change priority levels or channel numbers.

The 5 kHz and 50 kHz PWMs are the most time-critical functions. Those are assigned high priority. PPWA is assigned middle priority. The DIO is low performance and is assigned low priority. Refer to **Table C-6**.

Table C-6 First-Try System Configuration

Channel	Priority	Function ^{1, 2}
0	High	PWM at 50 kHz (needs a 10- μ s WCL)
1	High	PWM at 50 kHz (needs a 10- μ s WCL)
2	High	PWM at 5 kHz (needs a 100- μ s WCL)
8	Middle	PPWA at 5 kHz (needs a 200- μ s WCL)
15	Low	DIO as input at rate of 1 ms

NOTES:

1. 0% RAM collision rate

2. CPU clock rate = 16.67 MHz, or 60 ns per clock period

With this system configuration, worst-case service time for each active channel is determined as follows:

1. Longest state of PWM is 24 CPU clocks with four RAM accesses.
 $24 + (4 \text{ RAM accesses} \times 0 \times 2 \text{ CPU clock stalls}) = 24 \text{ CPU clocks}$
Channels 0-2 worst-case service time = 24 CPU clocks.
2. Longest state of PPWA in mode 0 is 44 CPU clocks with nine RAM accesses.
 $44 + (9 \text{ RAM accesses} \times 0 \times 2 \text{ CPU clock stalls}) = 44 \text{ CPU clocks}$
Channel 8 worst-case service time = 44 CPU clocks.

3. Longest state of DIO is ten CPU clocks with four RAM accesses.
 $10 + (4 \text{ RAM accesses} \times 0 \times 2 \text{ CPU clock stalls}) = 10 \text{ CPU clocks}$
 Channel 15 worst-case service time = 10 CPU clocks.

To find the WCL for channel 0, assume channel 0 has just finished service. Map the channels in the H-M-H-L-H-M-H sequence. See **Figure C-9**.

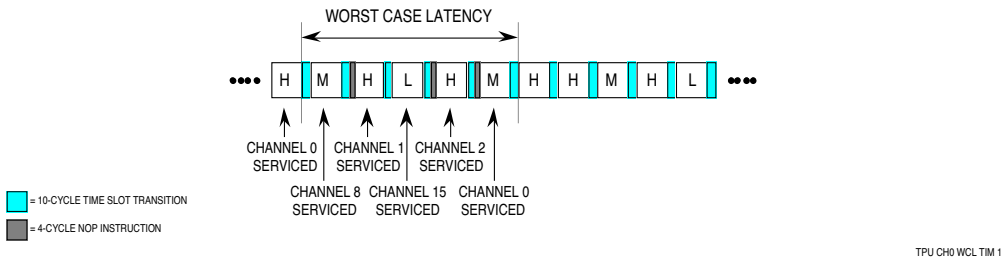

Figure C-9 Worst-Case Latency for Channel 0 (First Try)

Conclusion: with this system configuration, worst-case latencies for channels 0 and 1 are too high (WCL for channel 1 is the same as WCL for channel 0). Try a different system configuration.

C.5.2.2 Second-Try System Configuration

The second-try system configuration is shown in **Table C-7**.

Table C-7 Second-Try System Configuration

Channel	Priority	Function ^{1, 2}
0	High	PWM at 50 kHz (needs a 10- μ s WCL)
1	High	PWM at 50 kHz (needs a 10- μ s WCL)
2	Middle	PWM at 5 kHz (needs a 100- μ s WCL)
8	Middle	PPWA at 5 kHz (needs a 200- μ s WCL)
15	Low	DIO as input at rate of 1 ms

NOTES:

1. 0% RAM collision rate
2. CPU clock rate = 16.67 MHz, or 60 ns per clock period

To find the WCL for channel 0, assume channel 0 has just finished service. Map the channels in the H-M-H-L-H-M-H sequence. See **Figure C-10**.

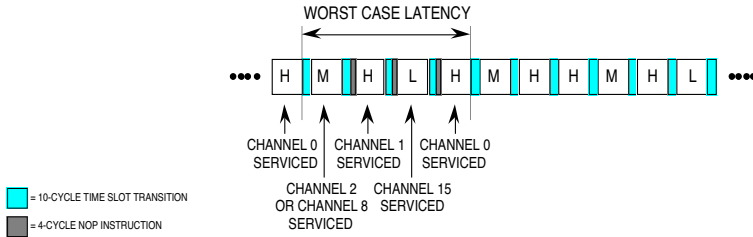

TPU CH0 WCL TIM 2

Figure C-10 Worst-Case Latency for Channel 0 (Second Try)

Conclusion: with this system configuration, the WCL of both channel 0 and channel 1 is 9.24 μ s, which is within the limit of 10 μ s needed for a 50-kHz PWM.

Next, find the WCL for channel 2. Assume channel 2 has just finished service. Map the channels in the H-M-H-L-H-M-H sequence. See **Figure C-11**.

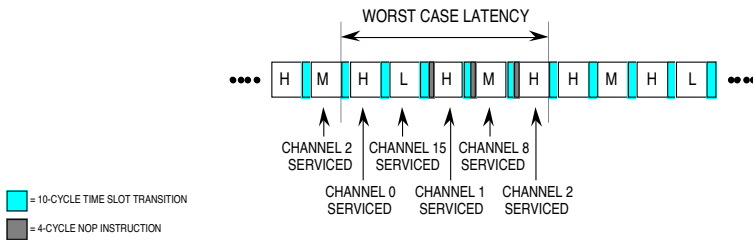

TPU CH2 WCL TIM 1

Figure C-11 Worst-Case Latency for Channel 2

Conclusion: with this system configuration, the WCL for channels 2 and 8 is 11.28 μ s, which is within the 100 and 200 μ s WCL requirements.

Notice that channels 2 and 8 are well within their WCL requirements. The system could be re-configured as shown in **Table C-7** to give channels 0 and 1 a larger margin while still keeping channels 2, 8 and 15 within their WCL requirements.

Table C-8 Second-Try System with Channel 0 and 1 Reconfigured

Channel	Priority	Function ^{1, 2}
0	High	PWM at 50 kHz (needs a 10- μ s WCL)
1	High	PWM at 50 kHz (needs a 10- μ s WCL)
2	Low	PWM at 5 kHz (needs a 100- μ s WCL)
8	Middle	PPWA at 5 kHz (needs a 200- μ s WCL)
15	Low	DIO as input at rate of 1 ms

NOTES:

1. 0% RAM collision rate
2. CPU clock rate = 16.67 MHz, or 60 ns per clock period

APPENDIX D CHANNEL HARDWARE DIAGRAM

Figure D-1 is a block diagram of the TPU channel control hardware. This diagram helps clarify the interaction of the event register, control signals, the I/O, and other channel features.

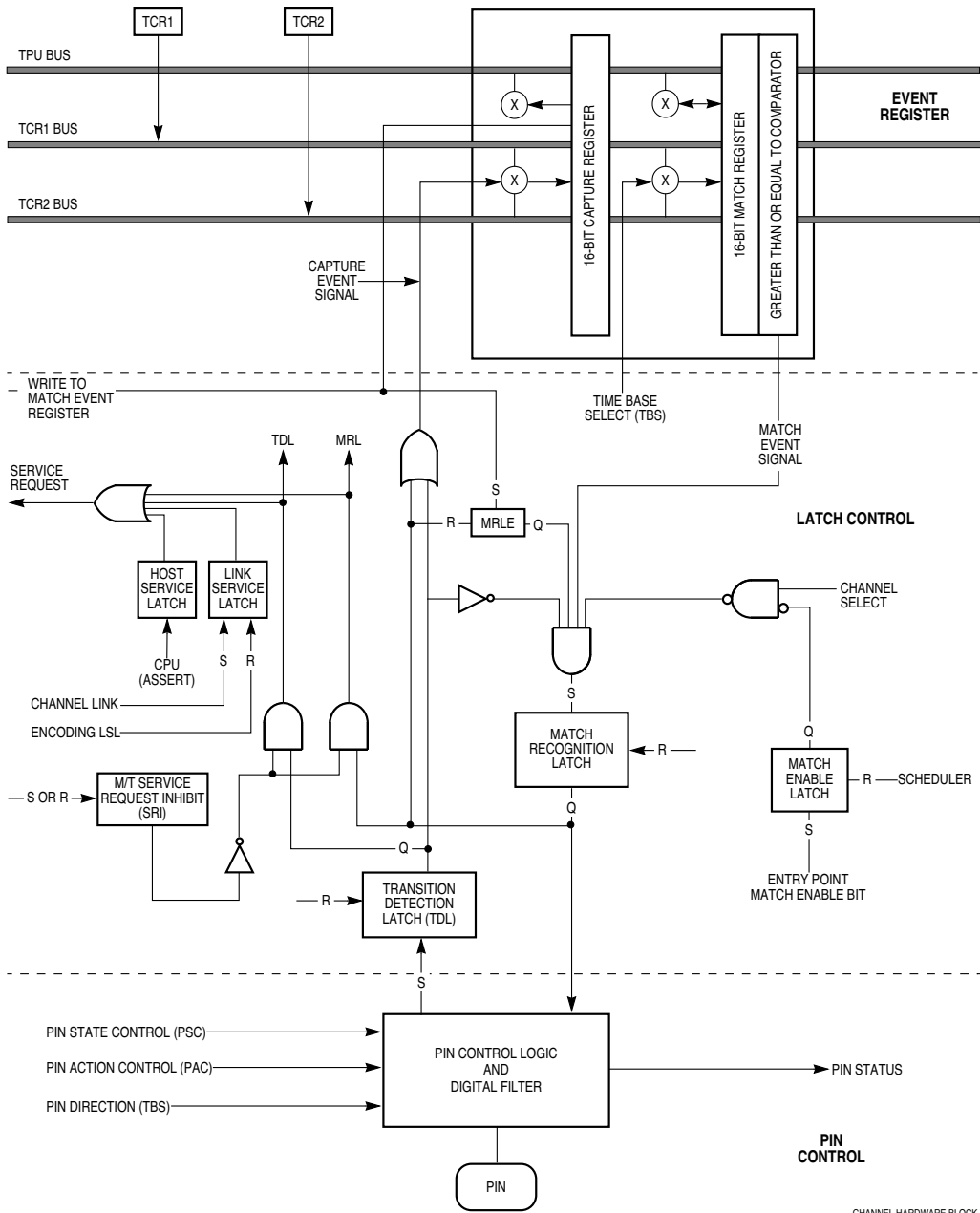

Figure D-1 Channel Hardware Block Diagram

INDEX

-A-

Adding time C-8

-B-

BC B-4
BH B-4
BKPT B-5
BL B-4
BLC B-4
BM B-4
BP B-4
Branch latch control (BLC) B-4
Breakpoint
 asserted flag (BKPT) B-5
 enable bits B-4
 flag (PCBK) B-5
BT B-4

-C-

CCL B-4
CFSR 2-11, B-6
Channel
 conditions latch (CCL) B-4
 function select registers (CFSR) 2-11, B-6
 hardware block diagram D-2
 interrupt
 base vector (CIBV) 2-11, B-6
 enable register (CIER) 2-10, B-6
 request level (CIRL) 2-11, B-5
 status register (CISR) 2-1, 2-10, B-8
 number priority C-5
 orthogonality 1-4
 parameter RAM 2-14
 priority registers (CPR) 2-13, B-7
 register breakpoint flag (CHBK) B-5
CHANNEL_CONTROL A-4
 options A-4
CHBK B-5
CIBV 2-11, B-6
CIER 2-10, B-6
CIRL 2-11, B-5
CISR 2-1, 2-10, B-8
CLKS B-4
Coherency 1-4
COMM A-42
Configuration
 examples

CPU16 2-21
CPU32 2-19
 summary 2-17

Control store 4-2
CPR 2-13, B-7
CPU16 2-8
CPU32 2-8

-D-

Data transfer 2-15
DCNR 2-10, B-9
Decoded channel number register (DCNR) 2-10, B-9
Development support 2-10
 control register (DSCR) 2-10, B-4
 status register (DSSR) 2-10, B-5
DIO A-21
Disable TPU2 pins field (DTPU) B-10
Discrete input/output (DIO) A-21
 parameters A-22
DIV2 2-6, B-9
Divide by two control field (DIV2) B-9
DSCR 2-10, B-4
DSSR 2-10, B-5
DTPU 2-8, B-10

-E-

EMU 2-4, B-2
Emulation
 mode 4-1
 memory 4-2
 memory map 4-2
 support 1-3
Entry
 point segments 4-2
 table bank select field (ETBANK) B-9
ETBANK 2-7, B-9

-F-

Fast quadrature decode TPU function (FQD) A-53
 parameters
 primary channel A-54
 secondary channel A-55
FPSCK 2-7, B-9
FQD A-53
FQM A-35
Frequency measurement (FQM) A-35
 parameters A-36

FRZ B-4
Function library 4-6

-H-

Hall effect decode (HALLD) A-51
parameters A-52
HALLD A-51
Hang on T4 (HOT4) B-4
Host
interface 1-2, 2-1
sequence registers (HSQR) 2-12, B-7
service request registers (HSRR) 2-12, B-7
HOT4 B-4
HSQR 2-12, B-7
HSRR 2-12, B-7

-I-

IARB 2-6, B-3
IMB FREEZE response (FRZ) B-4
Input capture/input transition counter (ITC) A-17
parameters A-18
Interchannel communication 1-4
Interrupt
arbitration 2-9
enabling 2-9
levels 2-8
vectors 2-9
ITC A-17

-L-

Link register (LR) 2-10, B-8
LR 2-10, B-8

-M-

Mapping channels C-8
Mask set
A time function encodings A-2
G time function encodings A-3
MCPWM A-44
Microengine 1-3
Module mapping (MM) bit 1-4
Multichannel pulse-width modulation (MCPWM) A-44
parameters
master mode A-45
slave channel A
inverted center aligned mode A-49
non-inverted center aligned mode A-47
slave channel B
inverted center aligned mode A-50
non-inverted center aligned mode A-48
slave edge-aligned mode A-46
Multiphase motor commutation (COMM) A-42
parameters A-43, A-44
Multiple time slot sequences C-4

-N-

New input capture/transition counter (NITC) A-40
parameters A-41
NITC A-40
No operation (NOP) C-5
NOP C-5

-O-

OC A-7
Output compare (OC) A-7
parameters A-8

-P-

PAC A-4
Parameter RAM 1-3
address map 2-14, B-10
PCBK B-5
Period
/pulse-width accumulator (PPWA) A-5
parameters A-6
measurement
w/ additional transition detection (PMA) A-13
parameters A-14
w/ missing transition detection (PMM) A-15
parameters A-16
Pin
action control (PAC) A-4
state control (PSC) A-4
PMA A-13
PMM A-15
Position-synchronized pulse generator (PSP) A-11
parameters A-12
PPWA A-5
Priority passing C-4
Programmable time accumulator (PTA) A-28
parameters A-29
PSC A-4
PSCK 2-5, B-3
PSP A-11
PTA A-28
Pulse-width modulation (PWM) A-19
parameters A-20
PWM A-19

-Q-

QDEC A-26
QOM A-30
Quadrature decode (QDEC) A-26
parameters A-27
Queued output match TPU function (QOM) A-30
parameters A-31

-R-

RAM collision rate (RCR) C-5
RCR C-5

-S-

Scheduler 1-3, C-3
Service
 grant latch (SGL) C-5
 grant latch register (SGLR) 2-10, B-9
 request breakpoint flag (SRBK) B-5
 request latch (SRL) C-5
SGL C-5
SGLR 2-10, B-9
SM A-9
Soft reset control field (SOFT_RST) B-9
SOFT_RST 2-6, B-9
SPWM A-23
SRBK B-5
SRL C-5
Stall time C-6
Stepper motor control (SM) A-9
 parameters A-10, A-11
STF 2-5, B-3
STOP 2-2
Stop
 clocks (to TCRs) B-4
Supervisor privilege level 1-4
SUPV 2-5, B-3
Synchronized pulse-width modulation (SPWM) A-23
 parameters A-24, A-25
System configuration 2-1

-T-

T2CF 2-8
T2CFILTER B-10
T2CG 2-4, B-3
T2CLK pin filter control (T2CFILTER) B-10
T2CSL 2-5, B-3
Table stepper motor (TSM) A-32
 parameters
 master mode A-33
 slave mode A-34
TCR 2-10, B-4
TCR1P 2-2, B-2
TCR2P 2-3, B-2
Test configuration register (TCR) 2-10, B-4
TICR 2-11, B-5
Time
 base/directionality selection A-4
 bases 1-2
 processor unit (TPU/TPU2) 1-1
 -slot
 sequence C-4
 transition C-5
Timer channels 1-2
TPU

block diagram 1-1
components 1-2
control store 4-2
emulation mode 4-1
FREEZE flag (TPUF) B-5
function
 states C-2
function library 4-6
interrupt configuration register (TICR) 2-11, B-5
mask sets A-1
memory map 1-4, B-1
module configuration register (TPUMCR) 2-1, B-2
overview 1-1
parameter RAM B-10
pins 1-6
programming note
 Time Processor Unit Programmer's Reference Manual 2-10
 Using the TPU Function Library and TPU Emulation Mode 1-2, 1-3, 2-4, 4-1, C-3
signal descriptions 1-6
TPU2
 enable bit 2-5, B-3
 module configuration register 2 (TPUMCR2) 2-1, B-9
TPUF B-5
TPUMCR 2-1, 2-2, B-2
TPUMCR2 2-1, 2-6, B-9
TSM A-32

-U-

UART A-37
Universal asynchronous receiver/transmitter (UART)
 A-37
 parameters
 receiver parameters A-39
 transmitter parameters A-38
User privilege level 1-4

-W-

WCL C-1
Worst-case latency (WCL) C-1
 assumptions and formula C-6
 defined C-1
 first-pass analysis C-6
 examples C-8
 for PWM C-1
 second-pass analysis C-11
 example C-12
 guidelines C-11
 using to evaluate performance C-3
 worst-case service time for each active channel C-7

